

**SECOND FLOOR SECTION**  
PAGE A230,A240

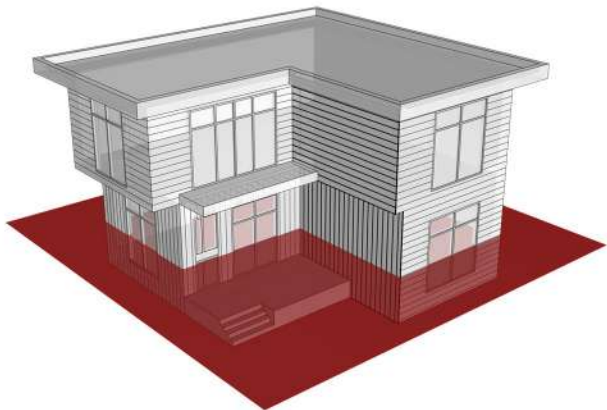

**FIRST FLOOR SECTION**  
PAGE A200,A210,A220

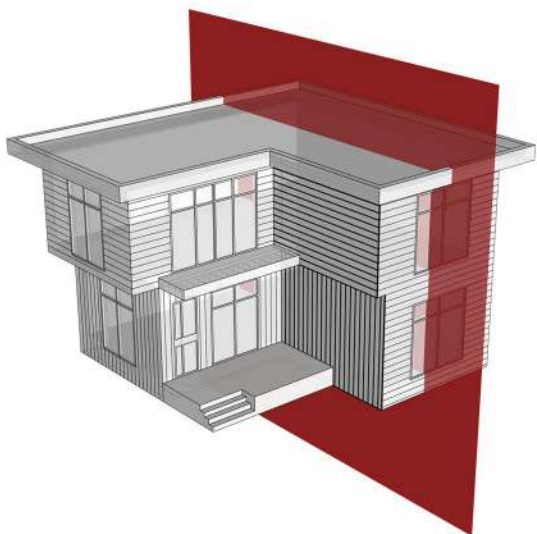

**SECTION A-A**  
PAGE A180,A190

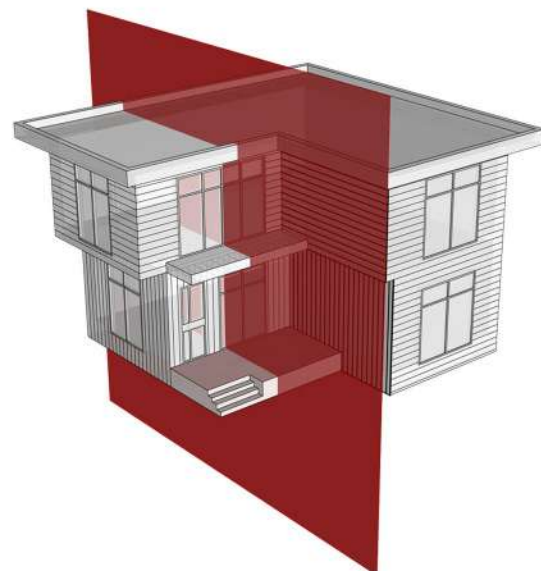

**SECTION B-B**  
PAGE A160,A170

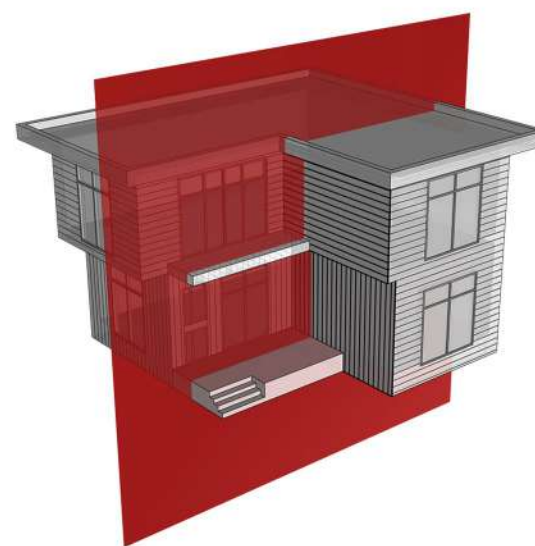

**SECTION C-C**  
PAGE A130,A140,A150

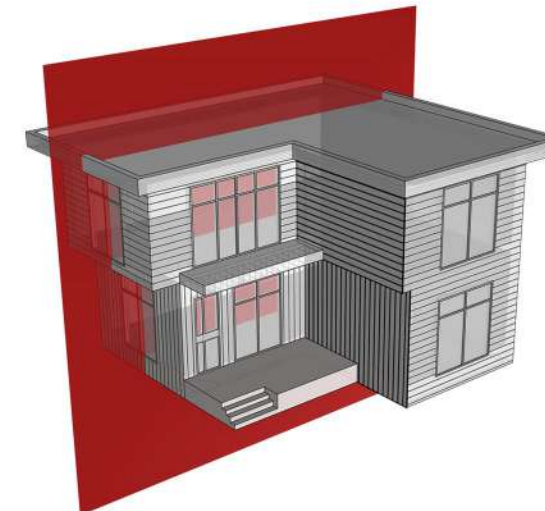

**SECTION D-D**  
PAGE A100,A110,A120

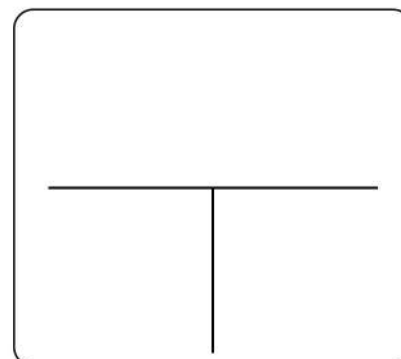

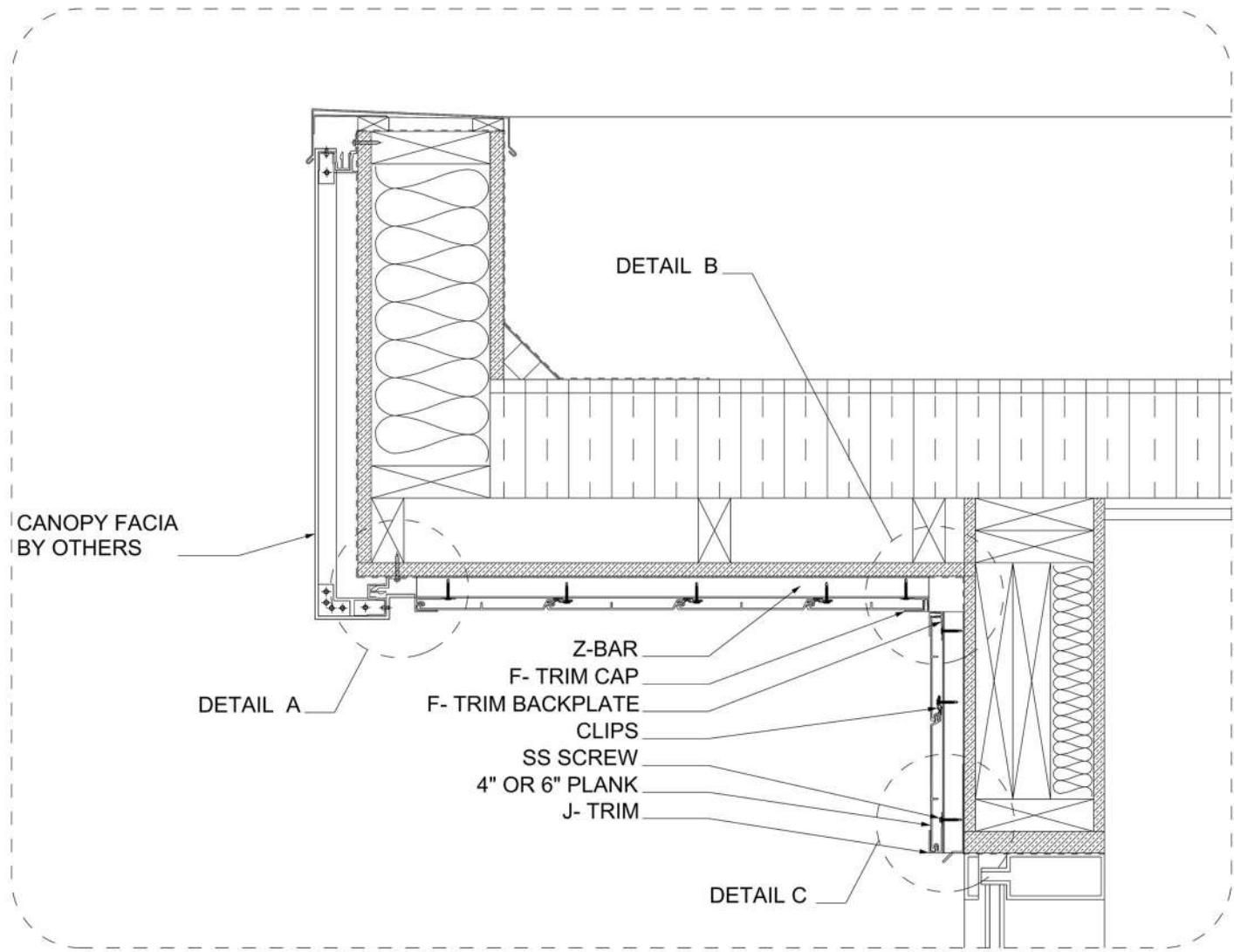

**D** DETAIL S-01  
 SCALE: 1.0" 2.0" 5.0"

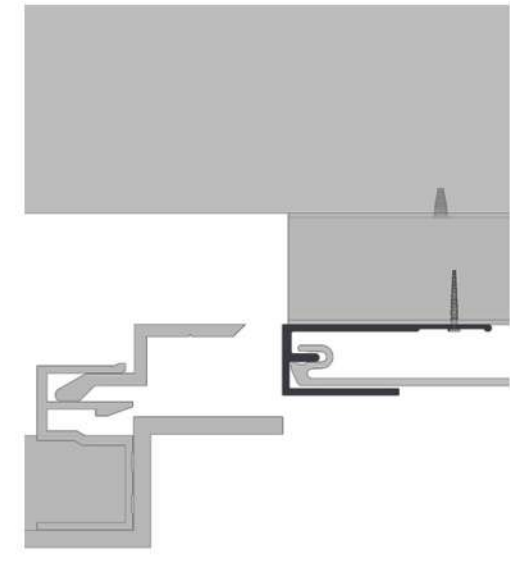
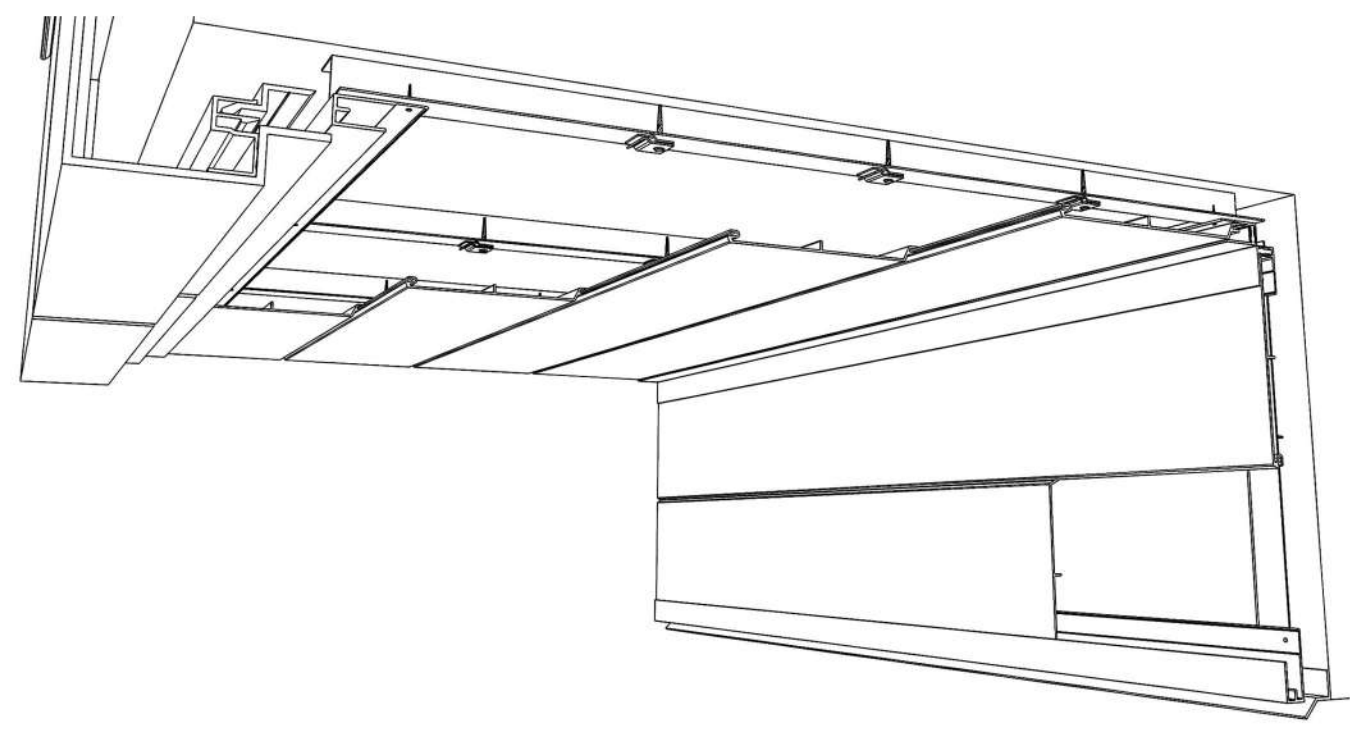

ENLARGED DETAIL A

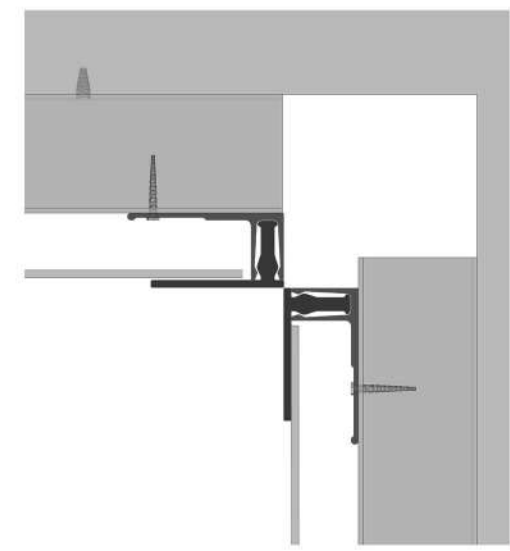

ENLARGED DETAIL B



ENLARGED DETAIL C

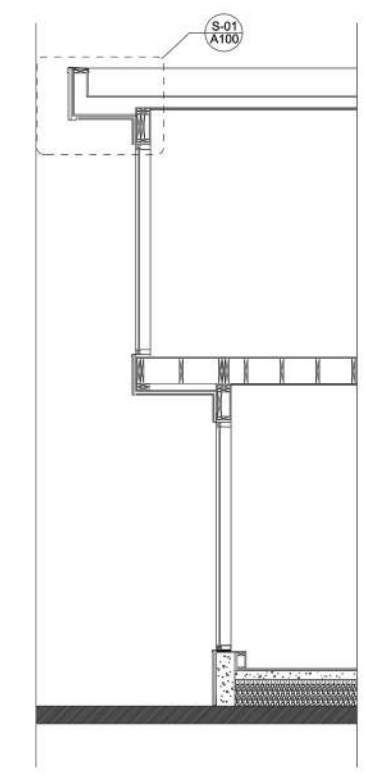
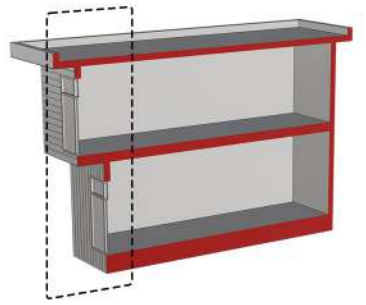
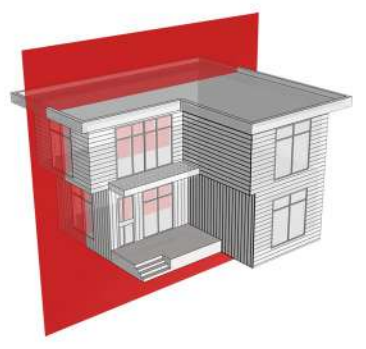

**VEDREX**  
 ALUMINUM SYSTEMS

**A**  
**100**

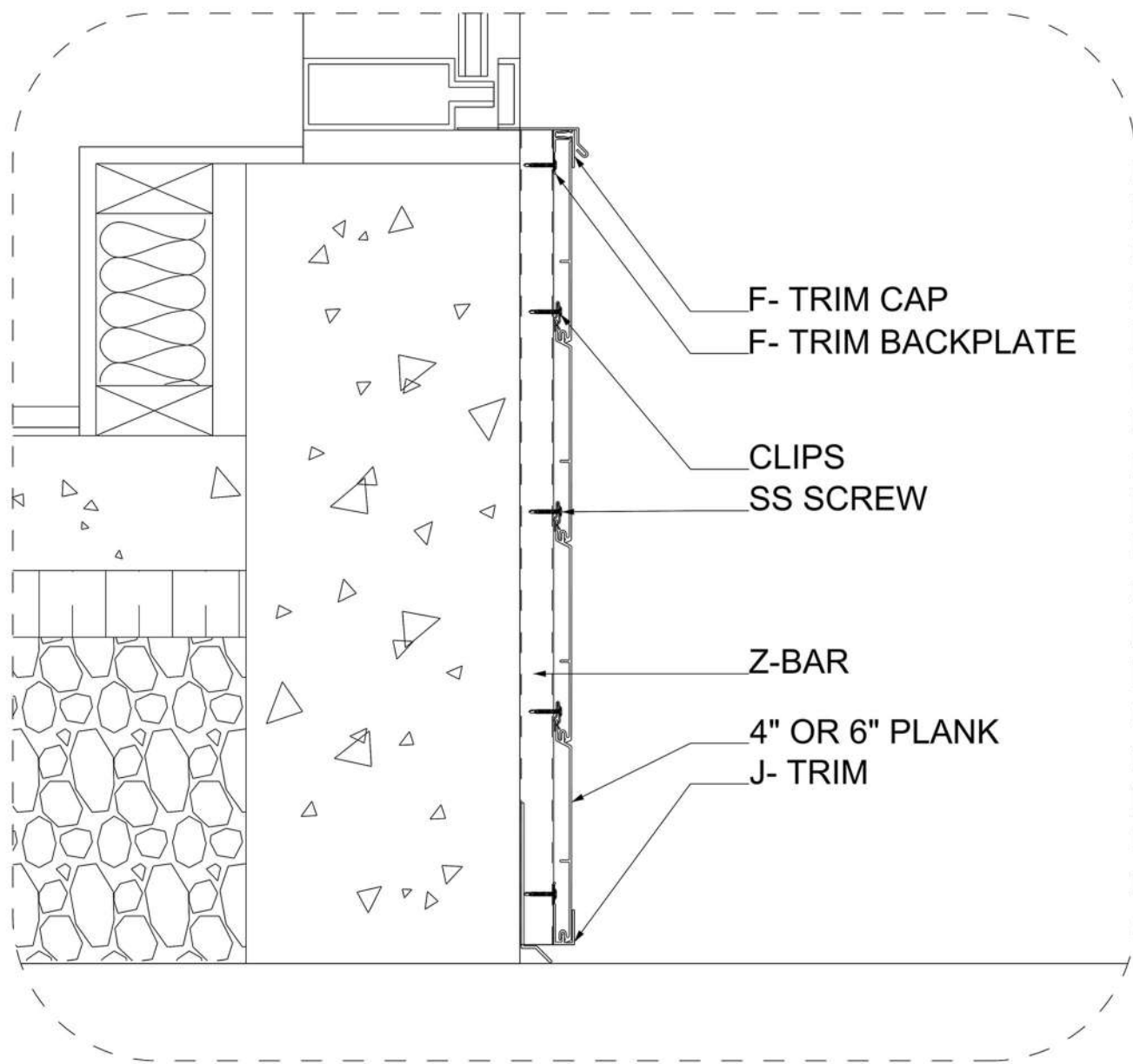

**D** DETAIL S-11

SCALE:

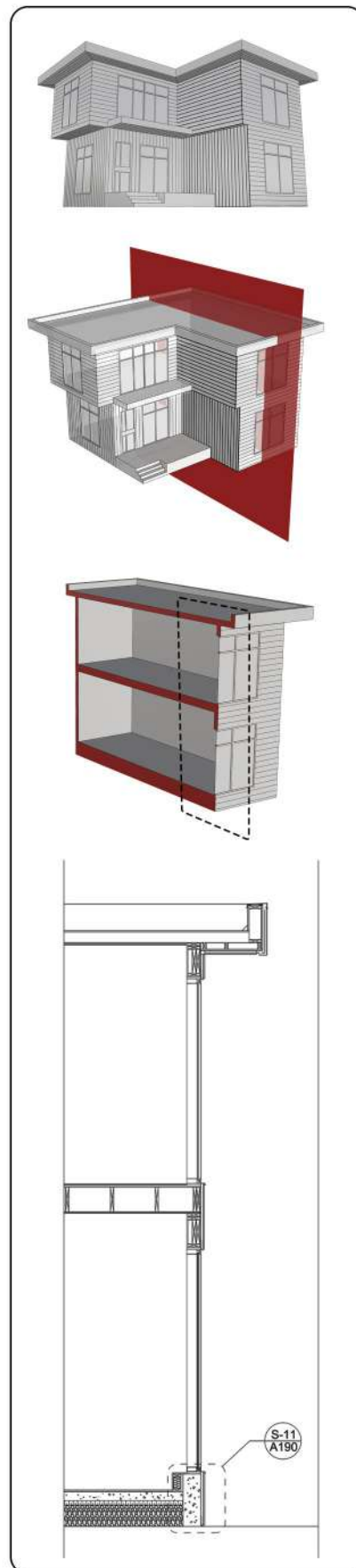
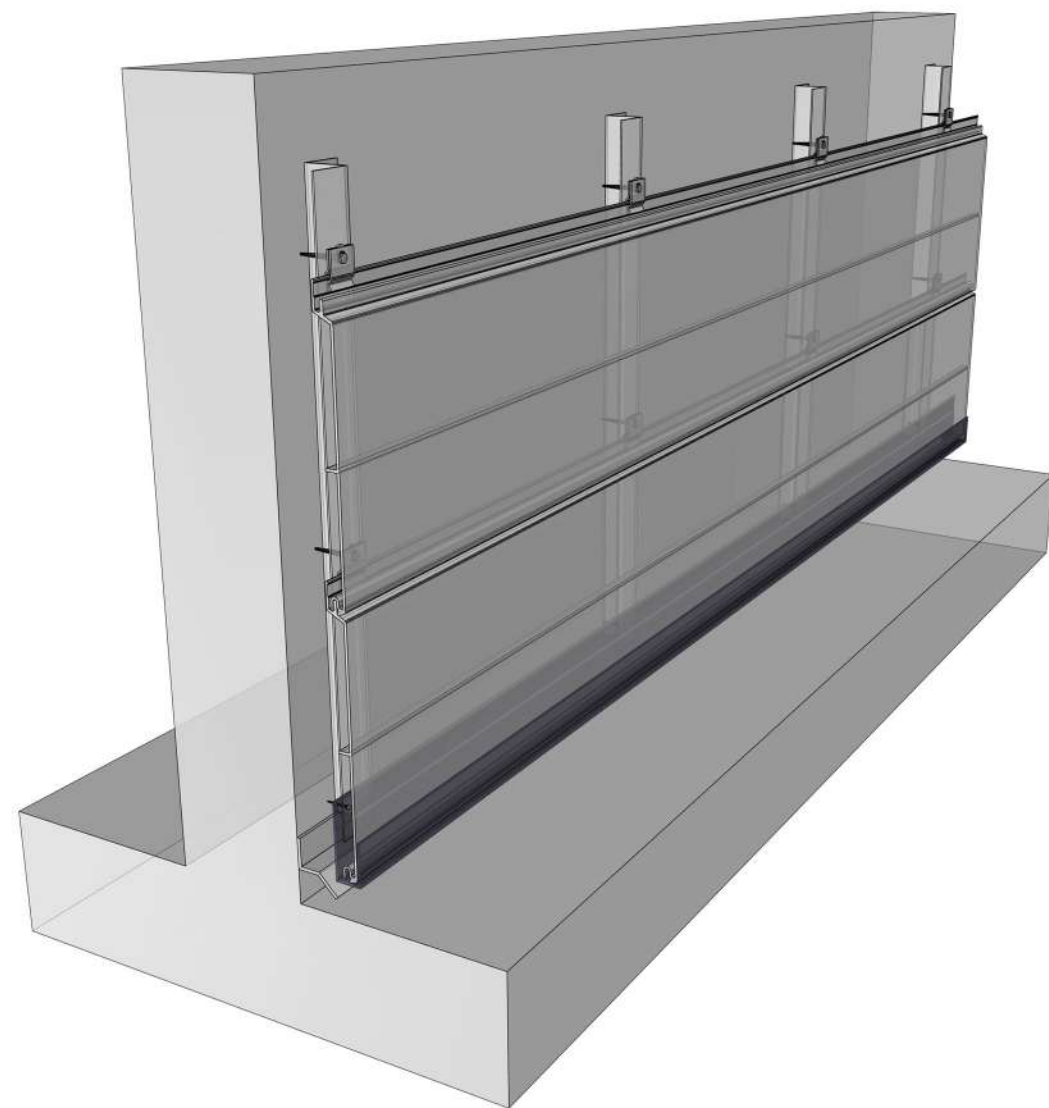
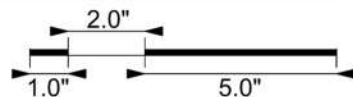

**VEDREX**  
ALUMINUM SYSTEMS

**A**  
**190**

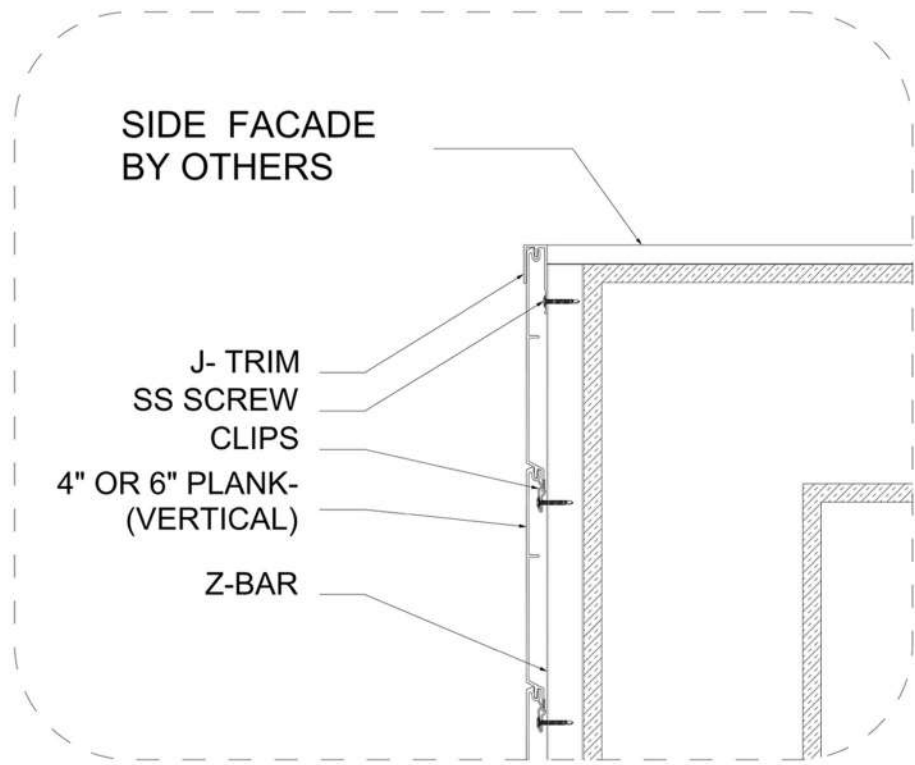

**D** **DETAIL D-01**  
 SCALE: 1.0" 2.0" 5.0"

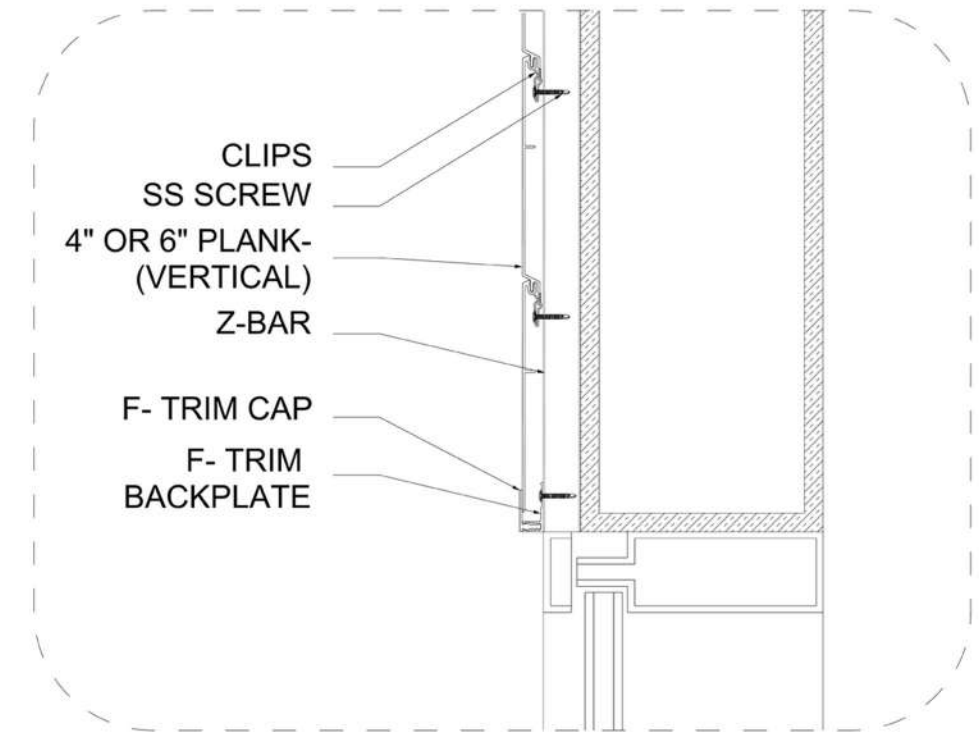

**D** **DETAIL D-02**  
 SCALE: 1.0" 2.0" 5.0"

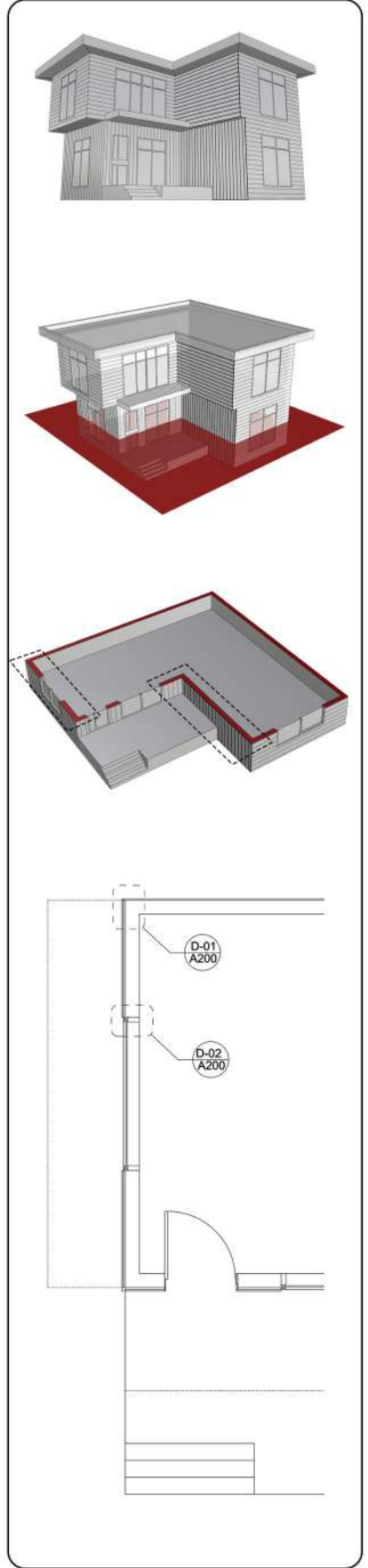
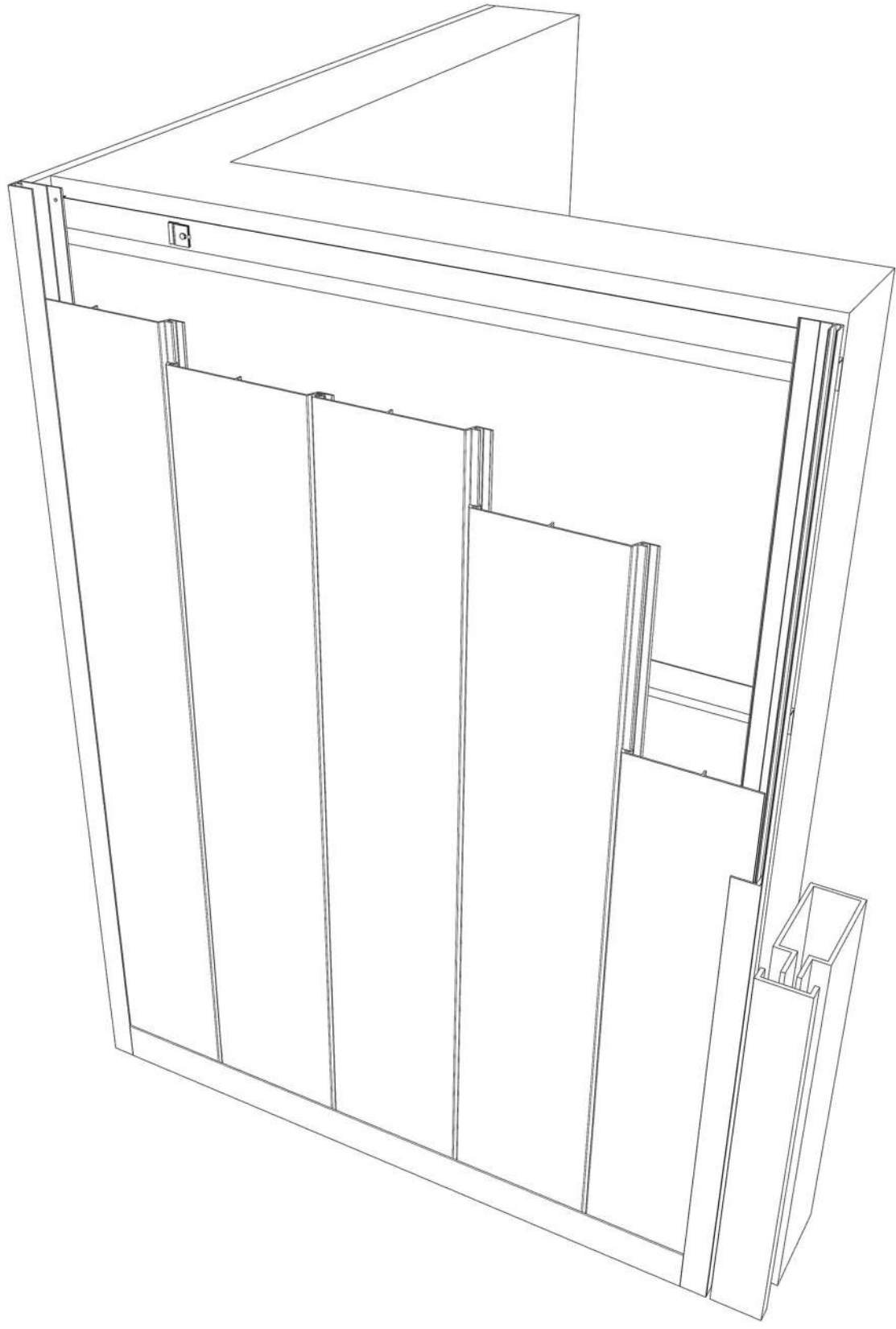

**VEDREX**  
 ALUMINUM SYSTEMS

**A**  
**200**

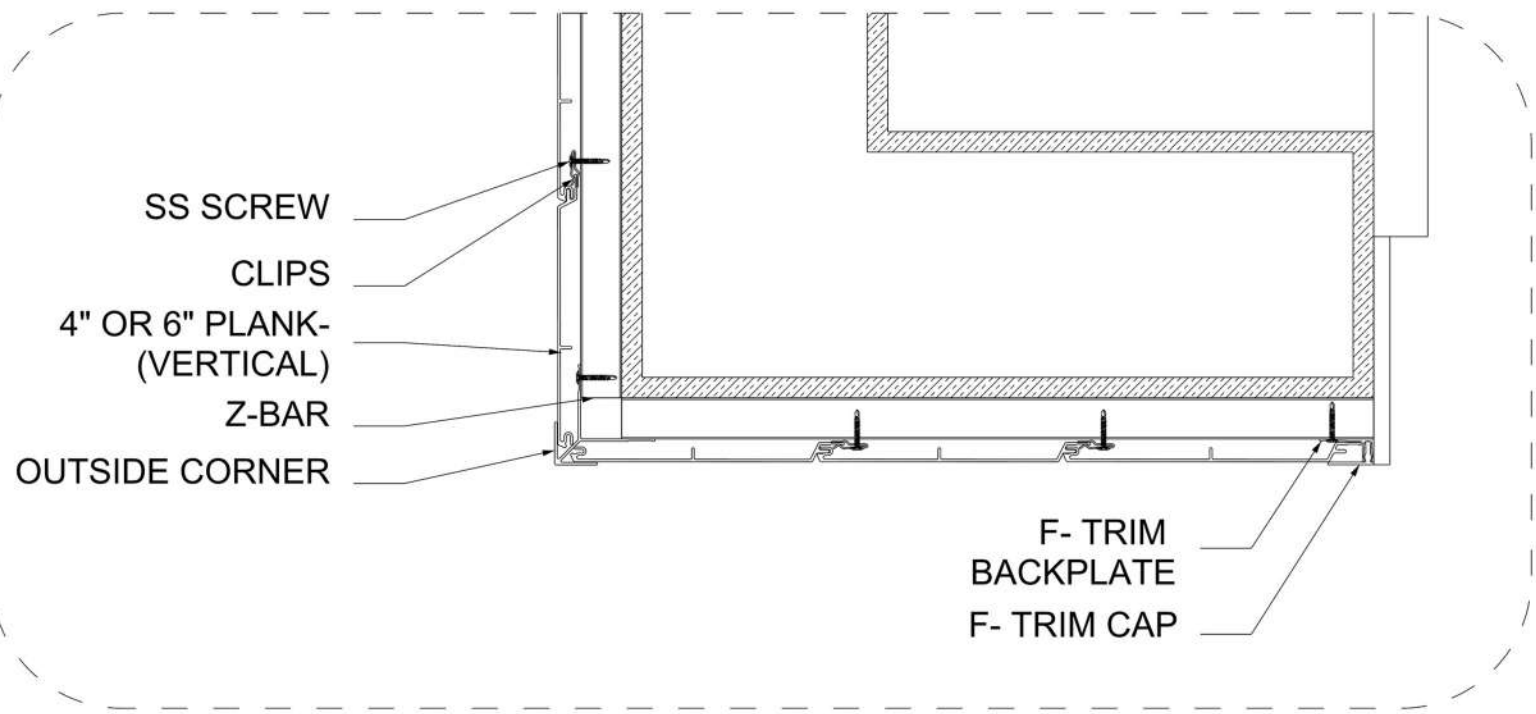

**D** DETAIL D-03

SCALE:

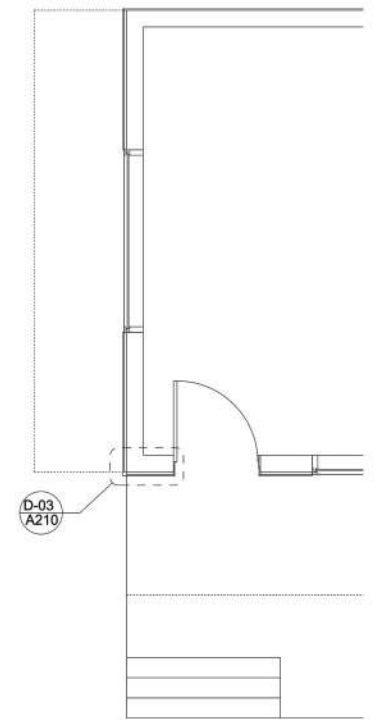
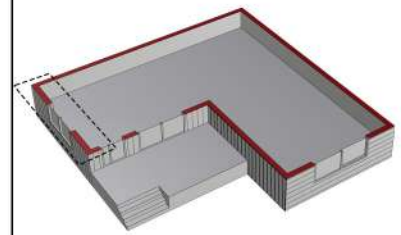
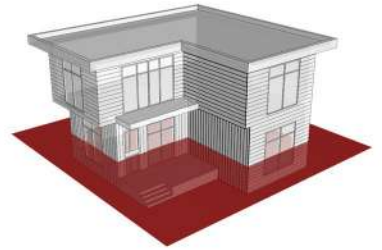
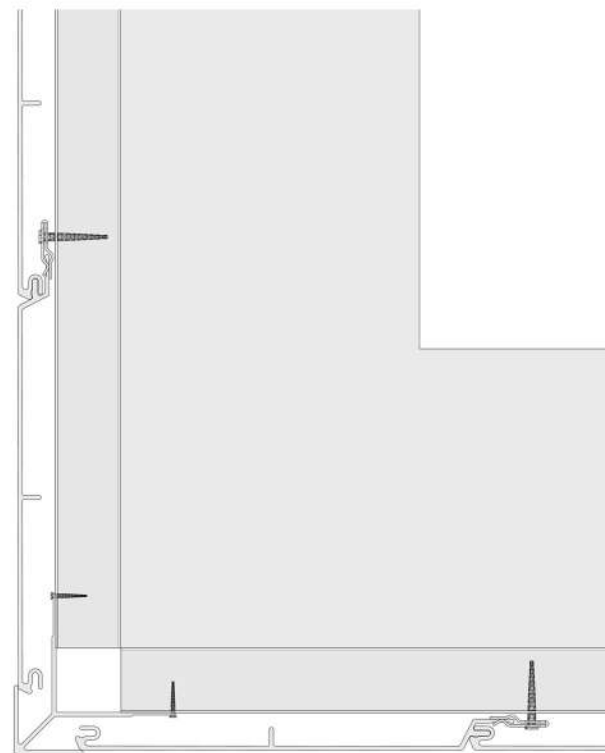
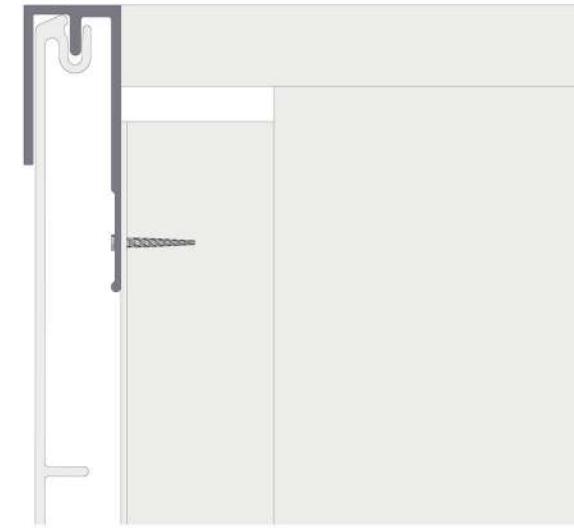
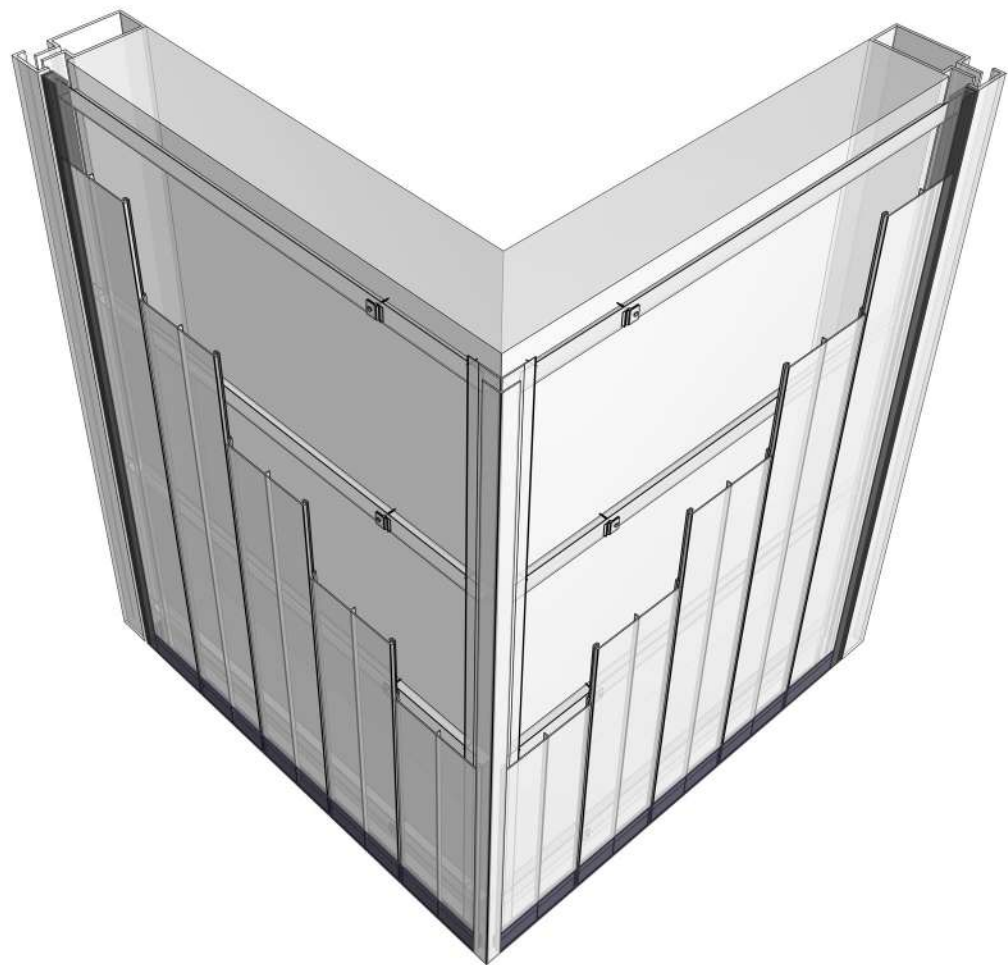
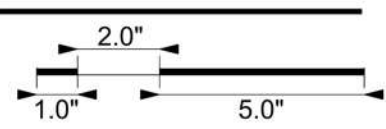

**VEDREX**  
 ALUMINUM SYSTEMS

**A**  
**210**

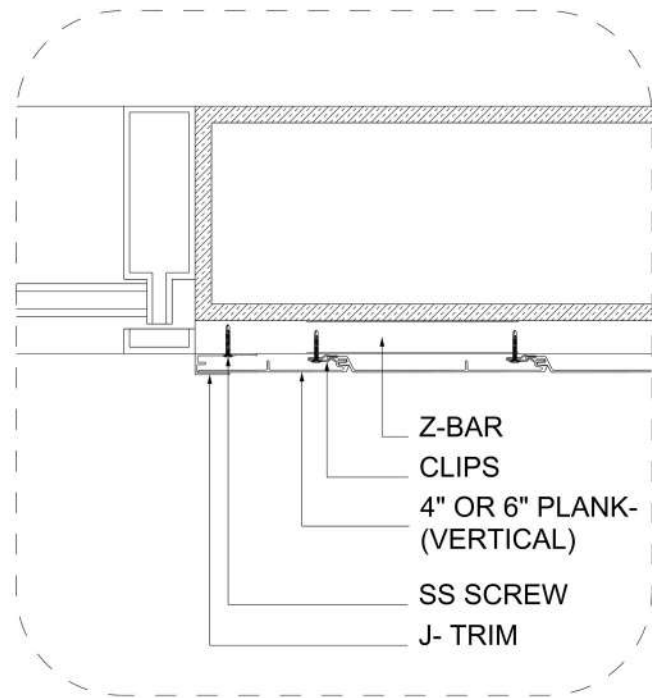

**D** **DETAIL D-04**  
**SCALE:**

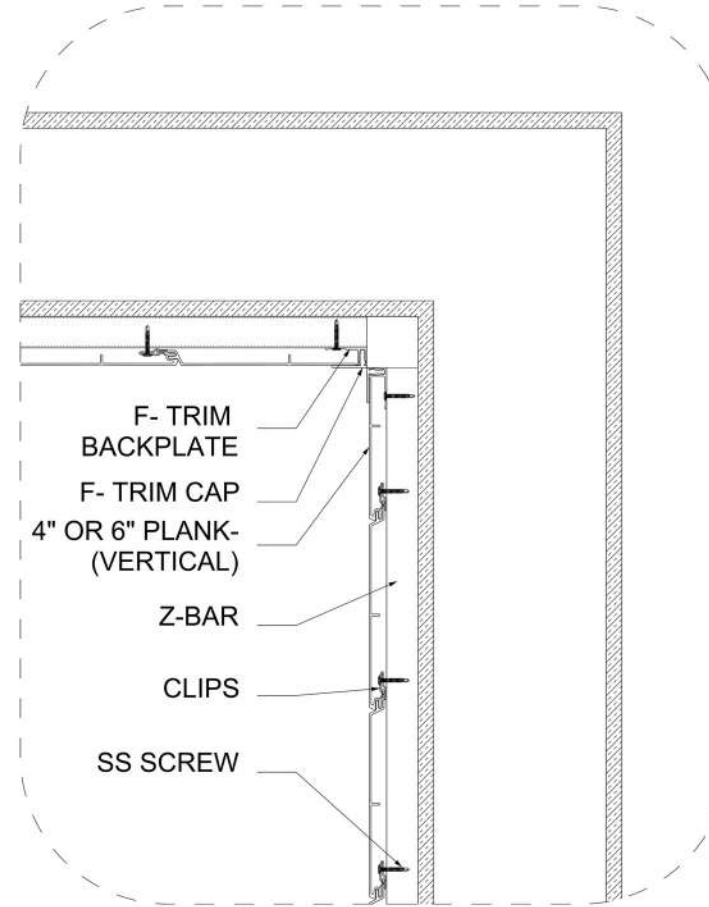

**D** **DETAIL D-05**  
**SCALE:**

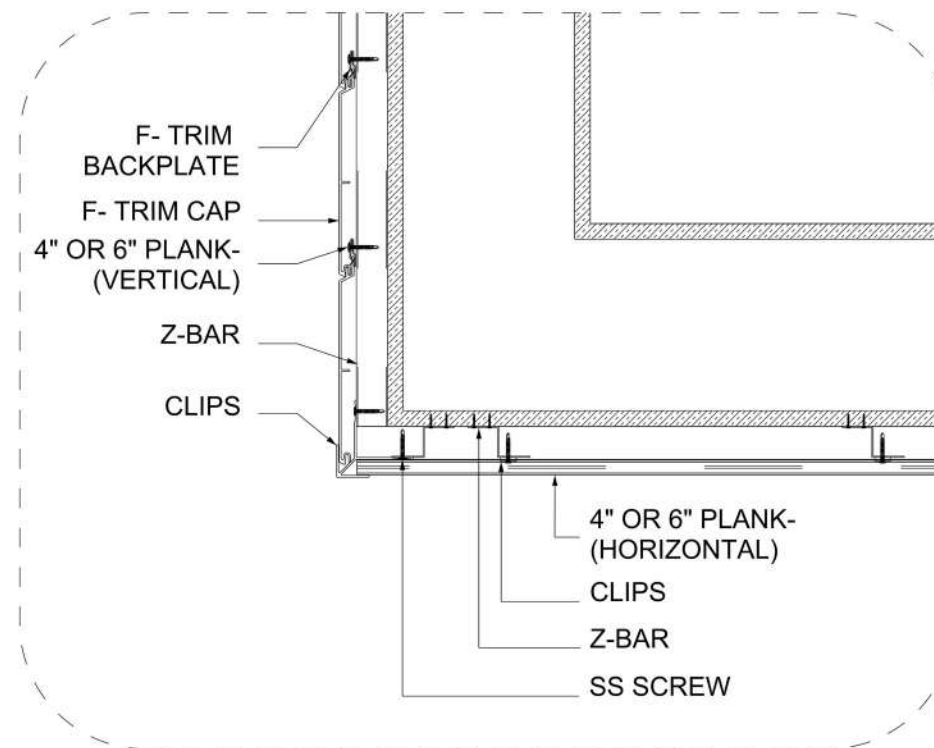
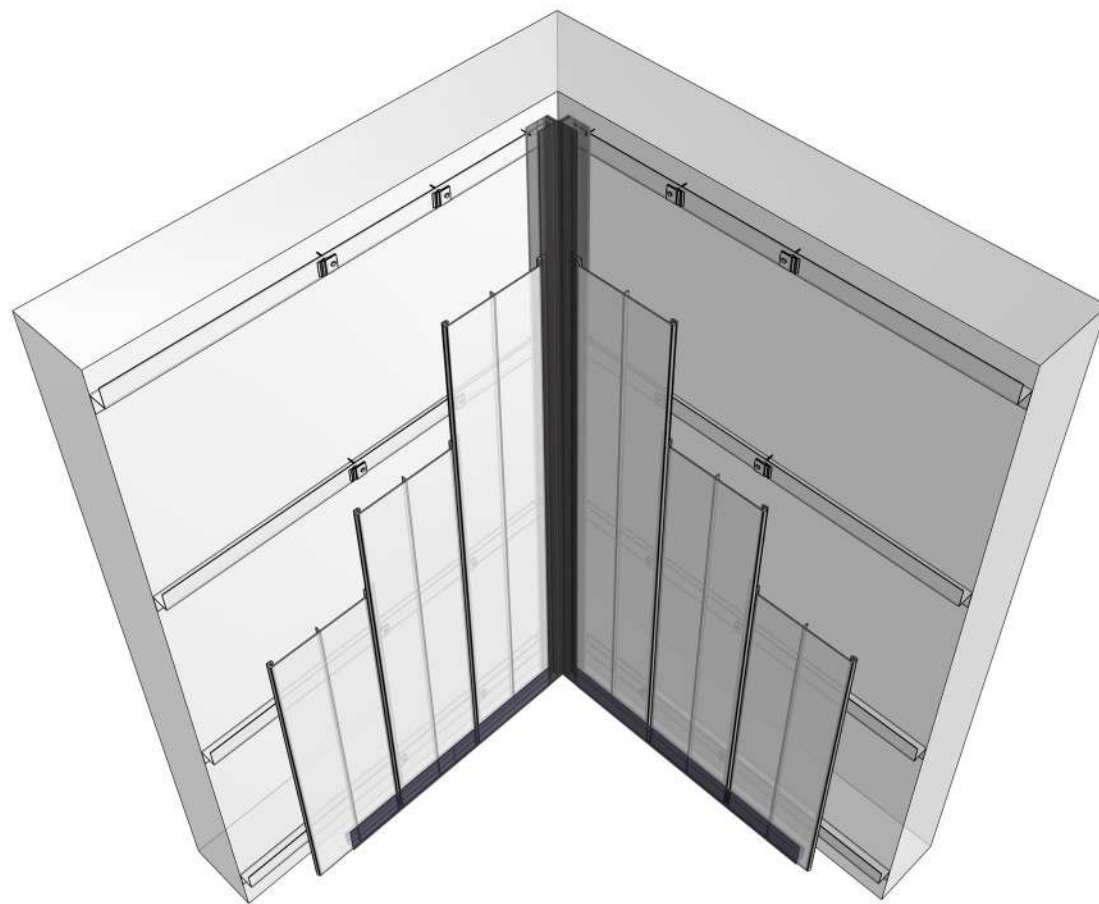

**D** **DETAIL D-06**  
**SCALE:**

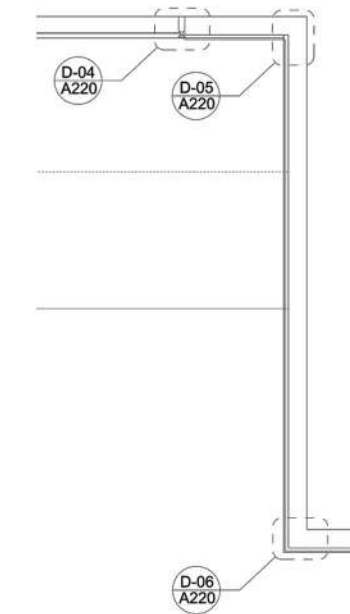
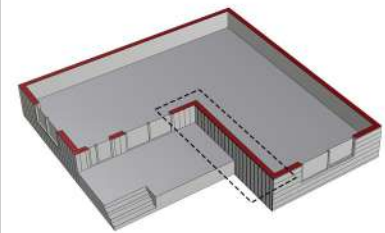
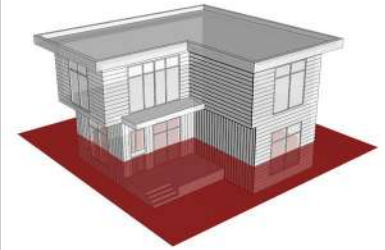

**VEDREX**  
 ALUMINUM SYSTEMS

**A**  
**220**

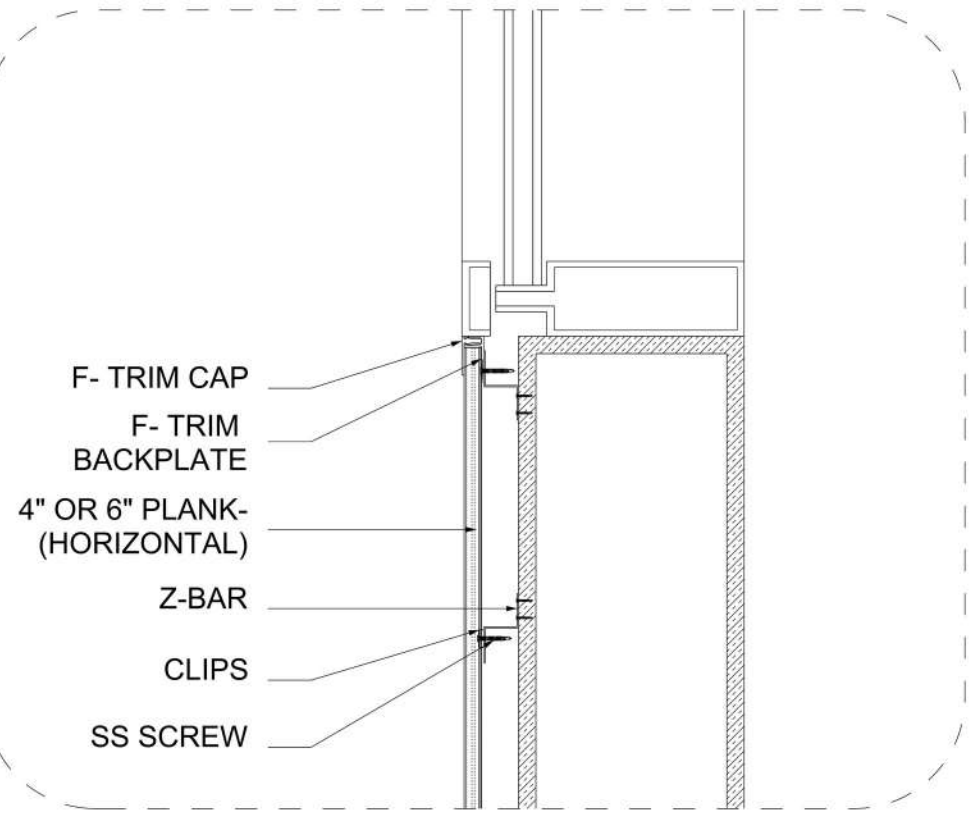
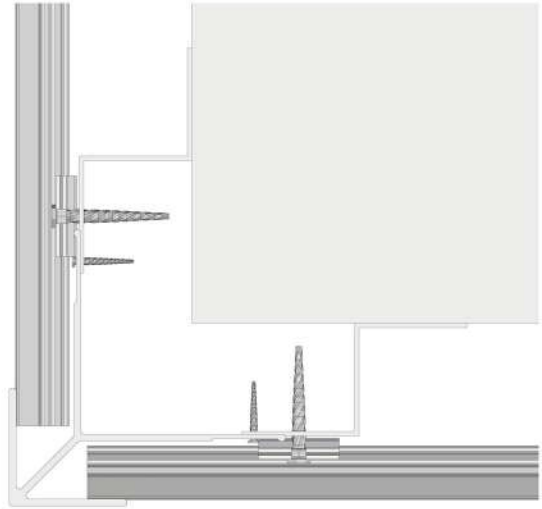

**D** **DETAIL D-08**  
 SCALE: 1.0" 2.0" 5.0"

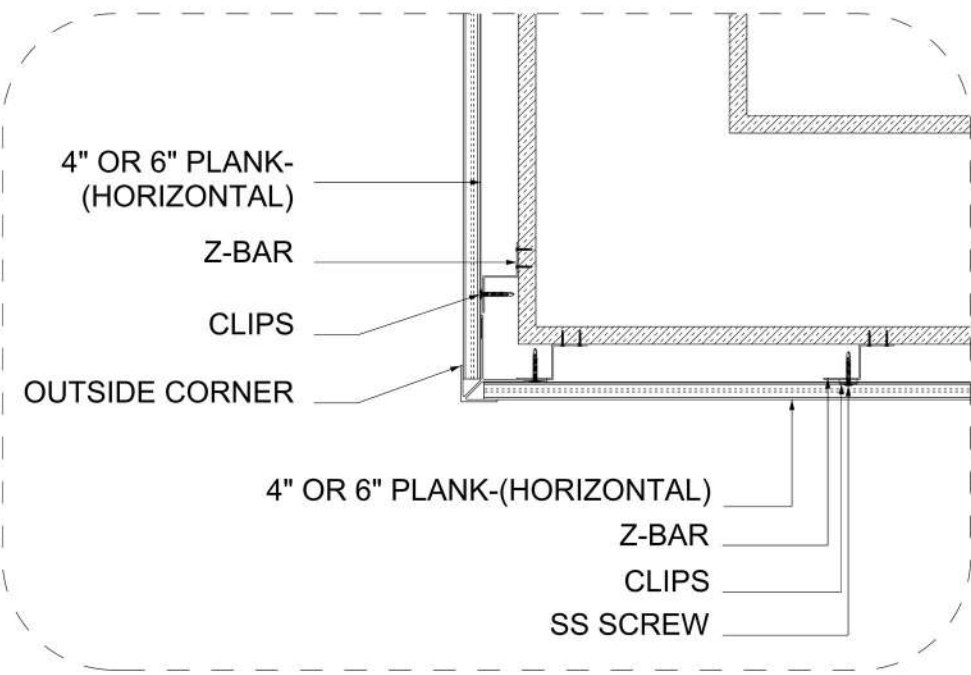

**D** **DETAIL D-09**  
 SCALE: 1.0" 2.0" 5.0"

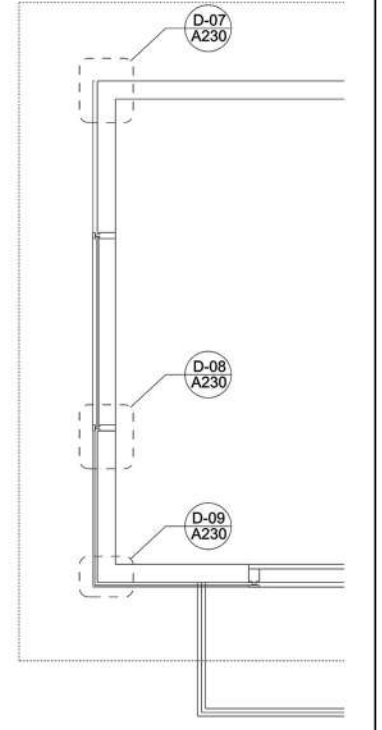
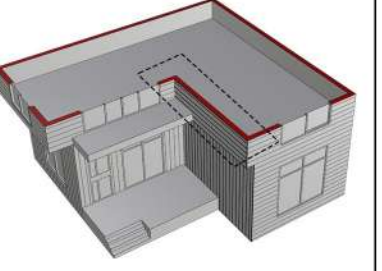
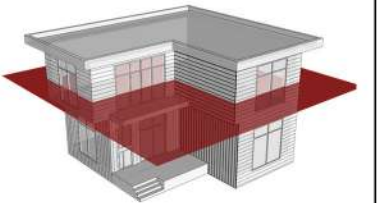
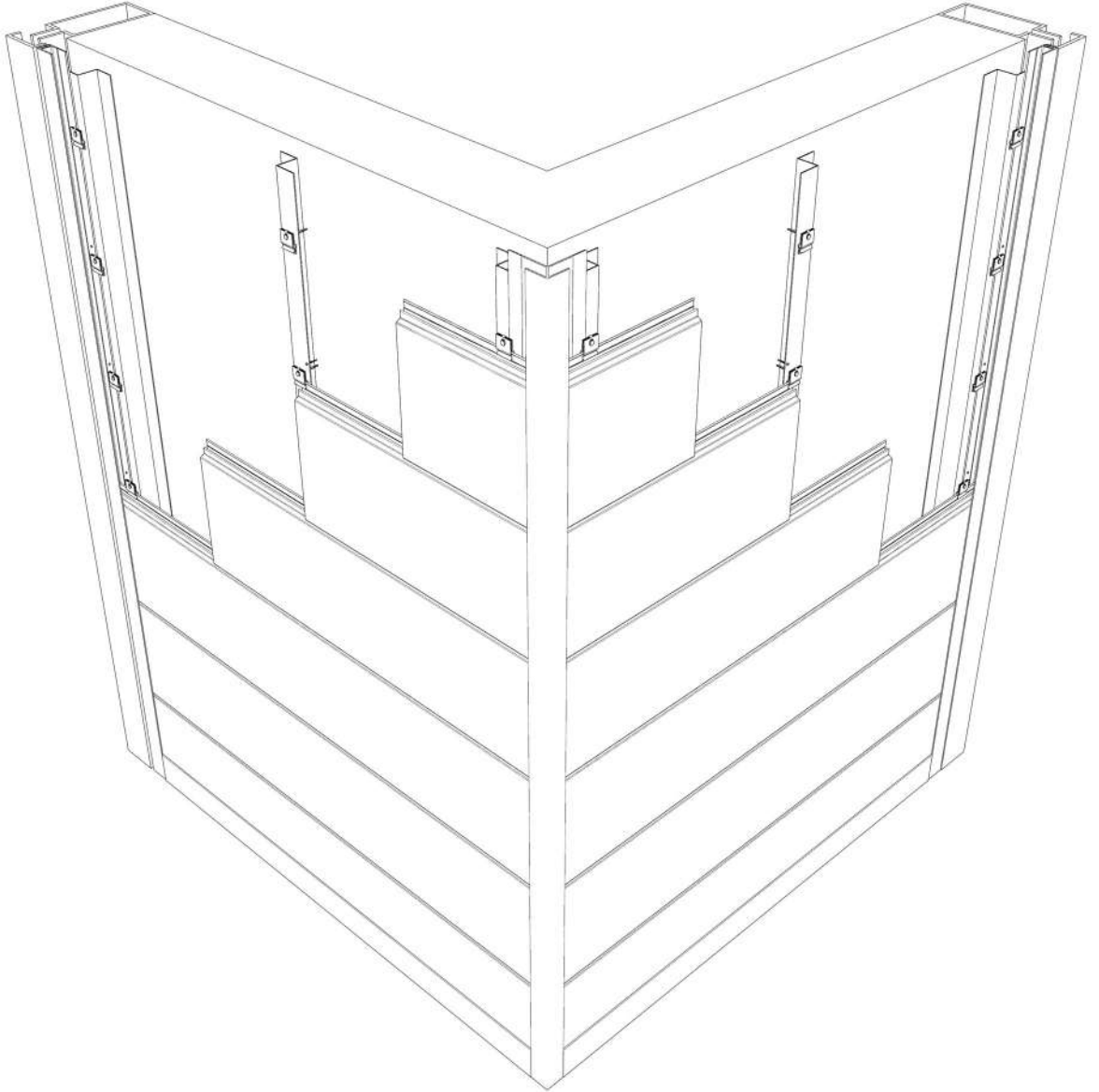

**VEDREX**  
 ALUMINUM SYSTEMS

**A**  
**230**

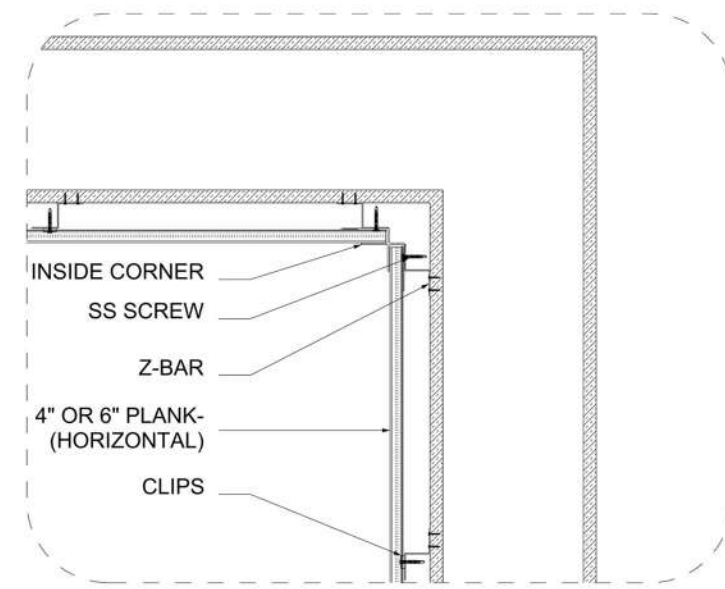
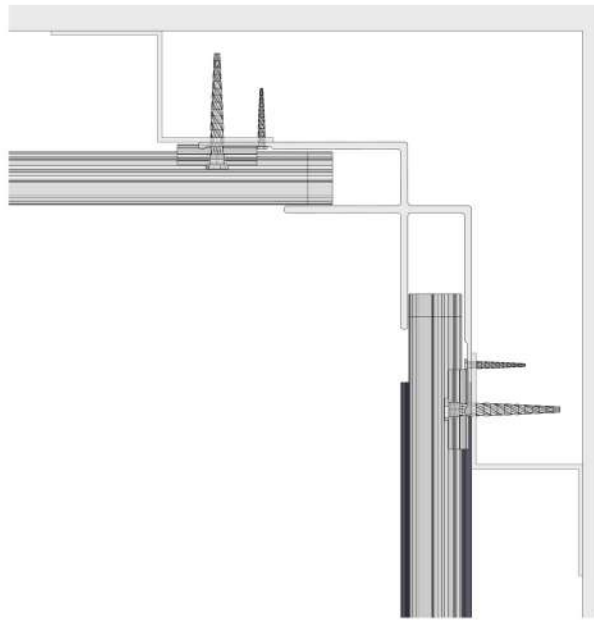

**D** **DETAIL D-10**  
 SCALE: 1.0" 2.0" 5.0"

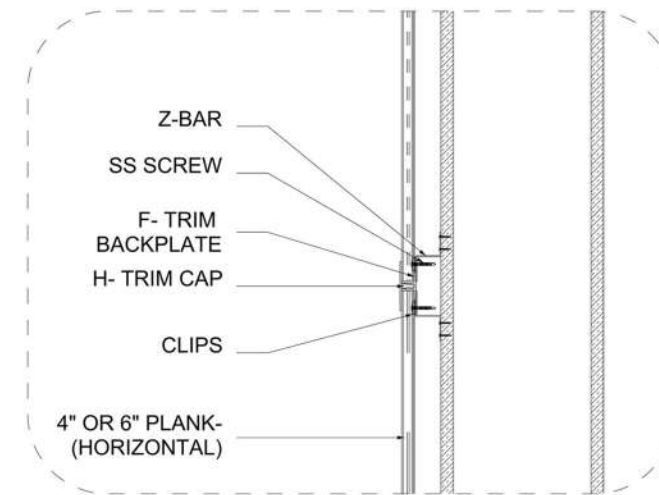

**D** **DETAIL D-11**  
 SCALE: 1.0" 2.0" 5.0"

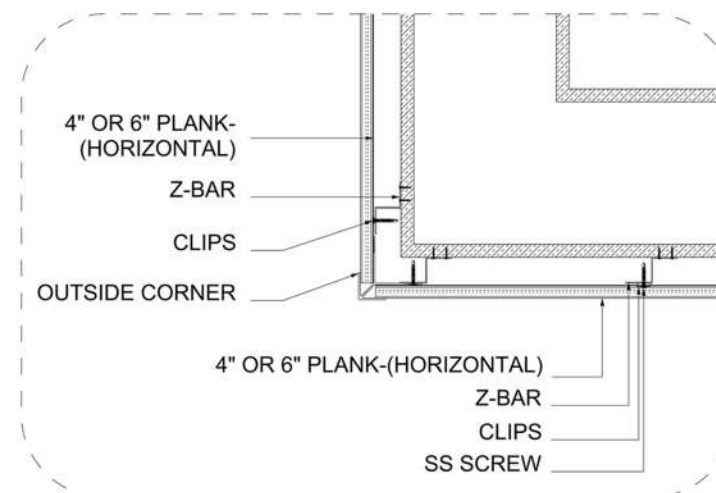

**D** **DETAIL D-12**  
 SCALE: 1.0" 2.0" 5.0"

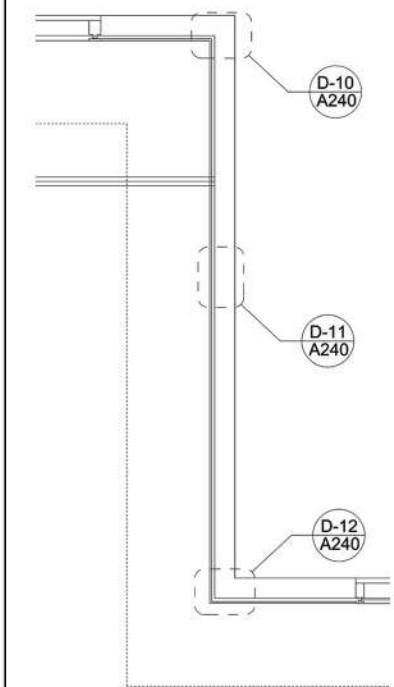
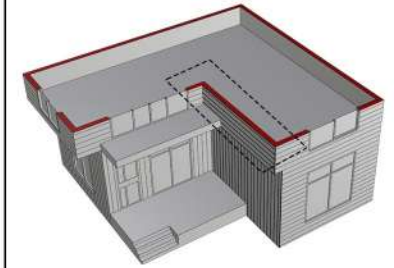
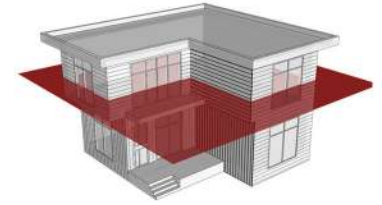

**VEDREX**  
 ALUMINUM SYSTEMS

---

**A**  
**240**

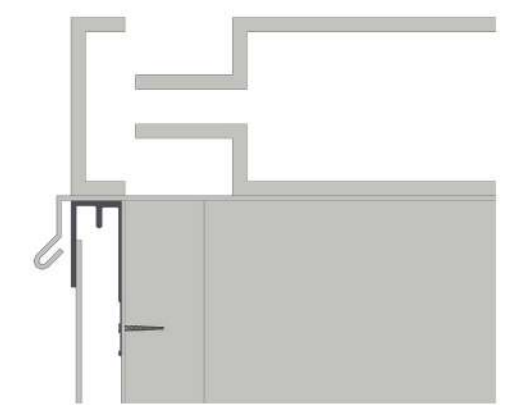
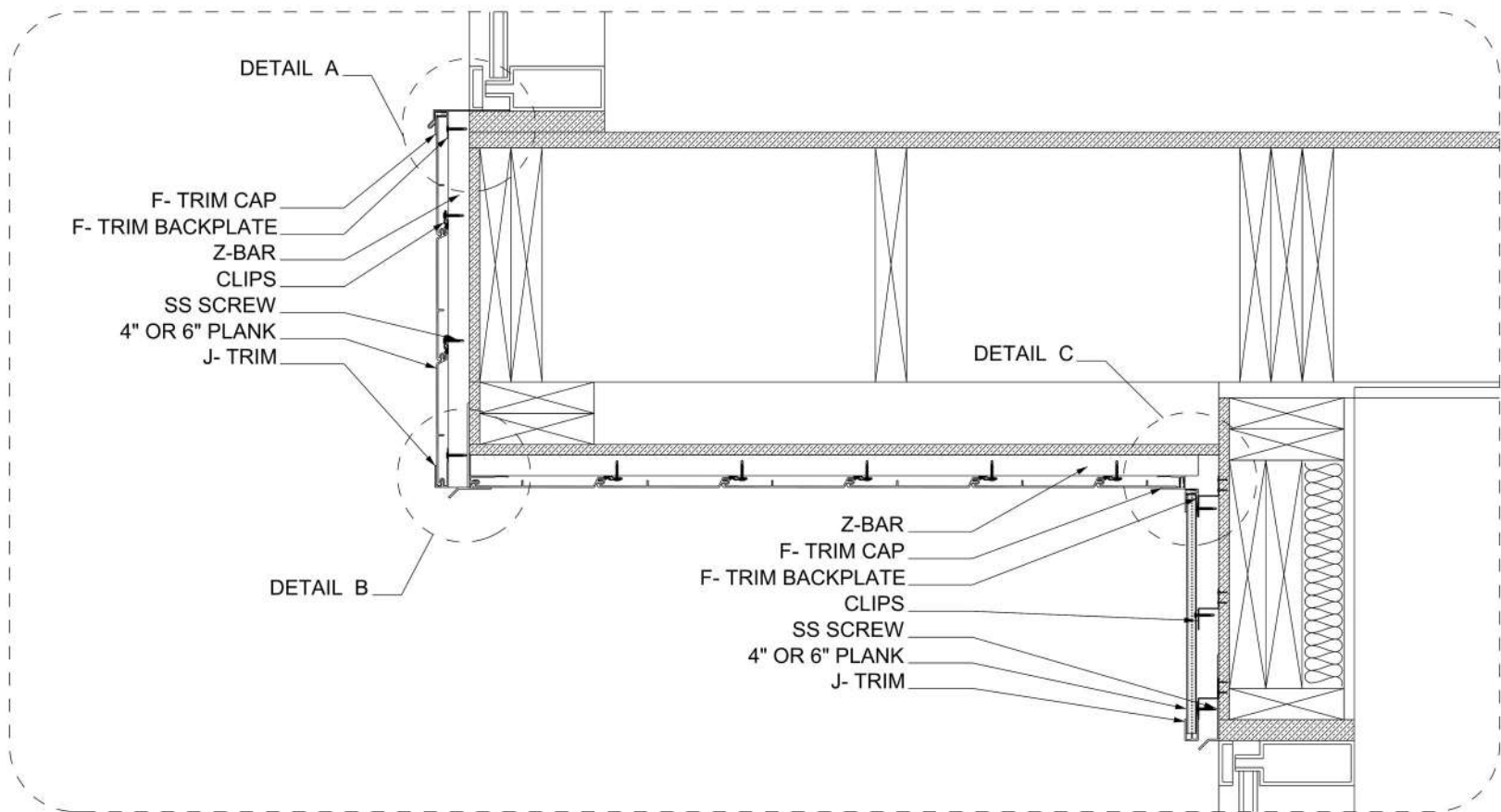

ENLARGED DETAIL A

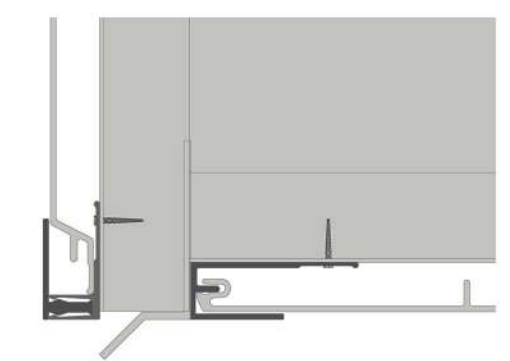

ENLARGED DETAIL B

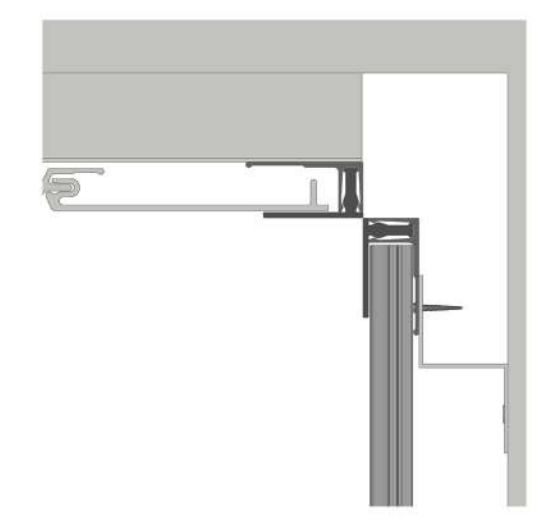

ENLARGED DETAIL C

**D** DETAIL S-02  
 SCALE:

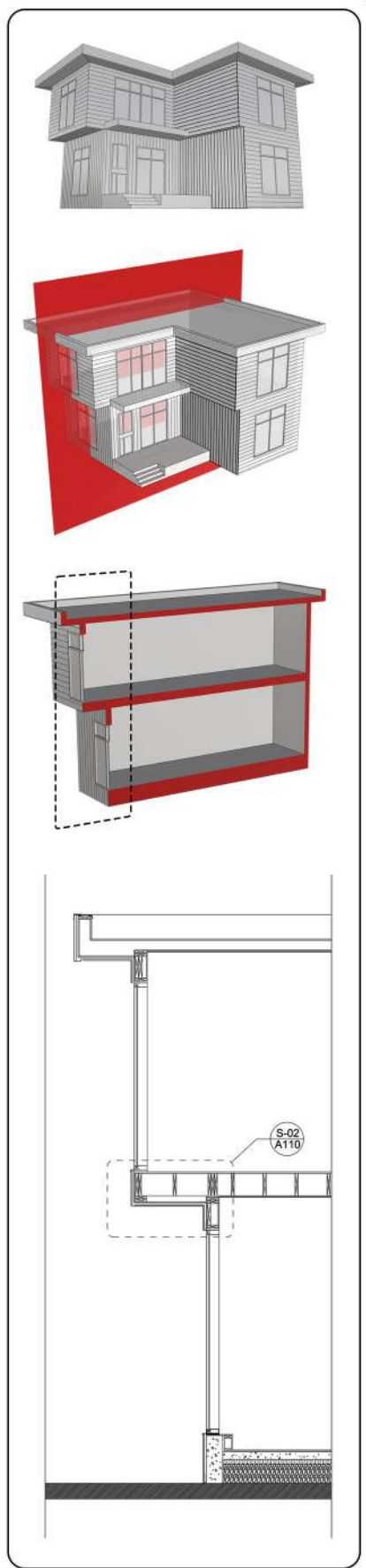
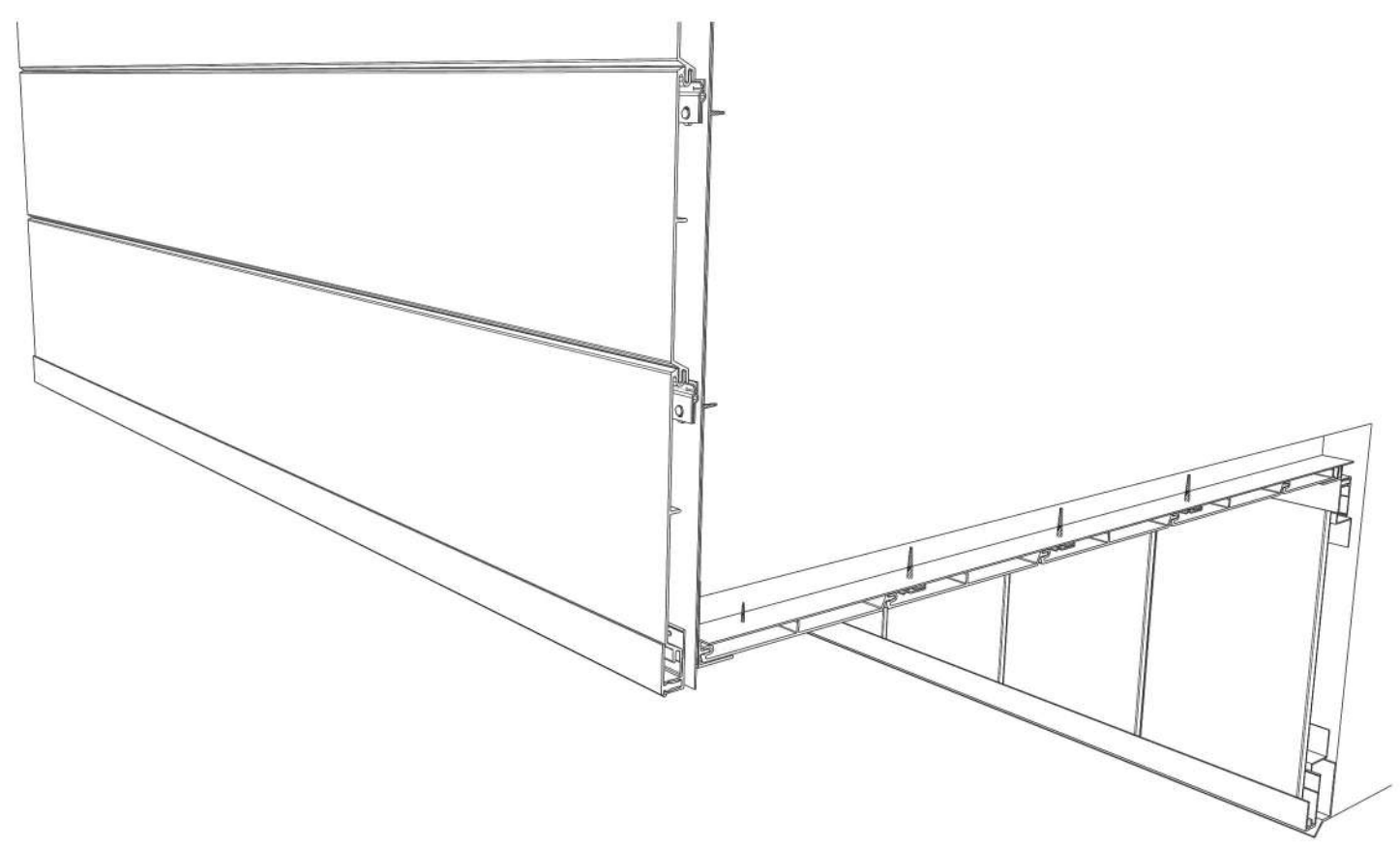

**VEDREX**  
 ALUMINUM SYSTEMS

---

**A**  
**110**

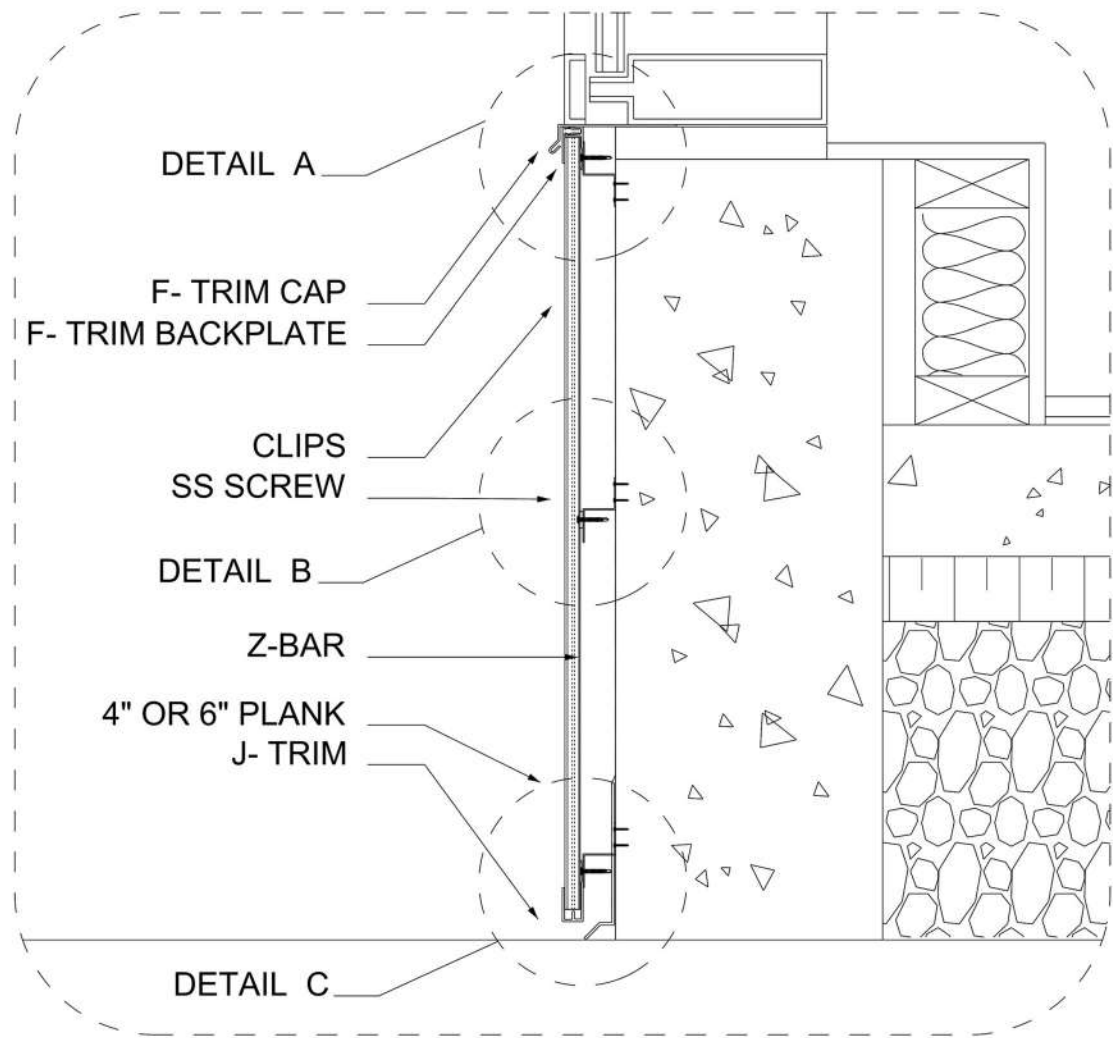

**D** DETAIL S-03  
 SCALE:

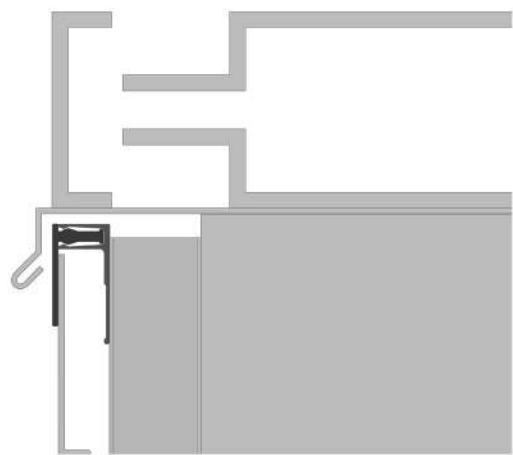
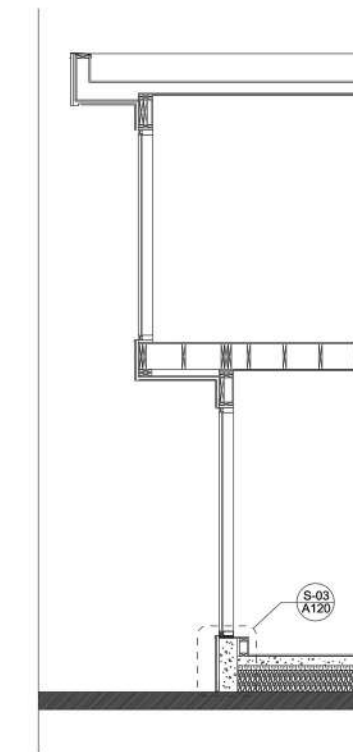
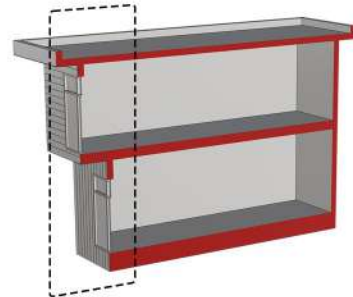
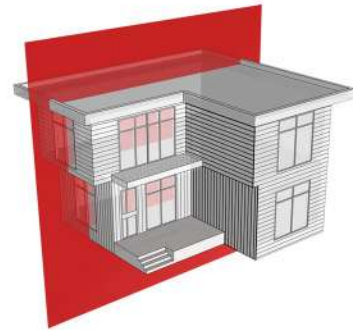
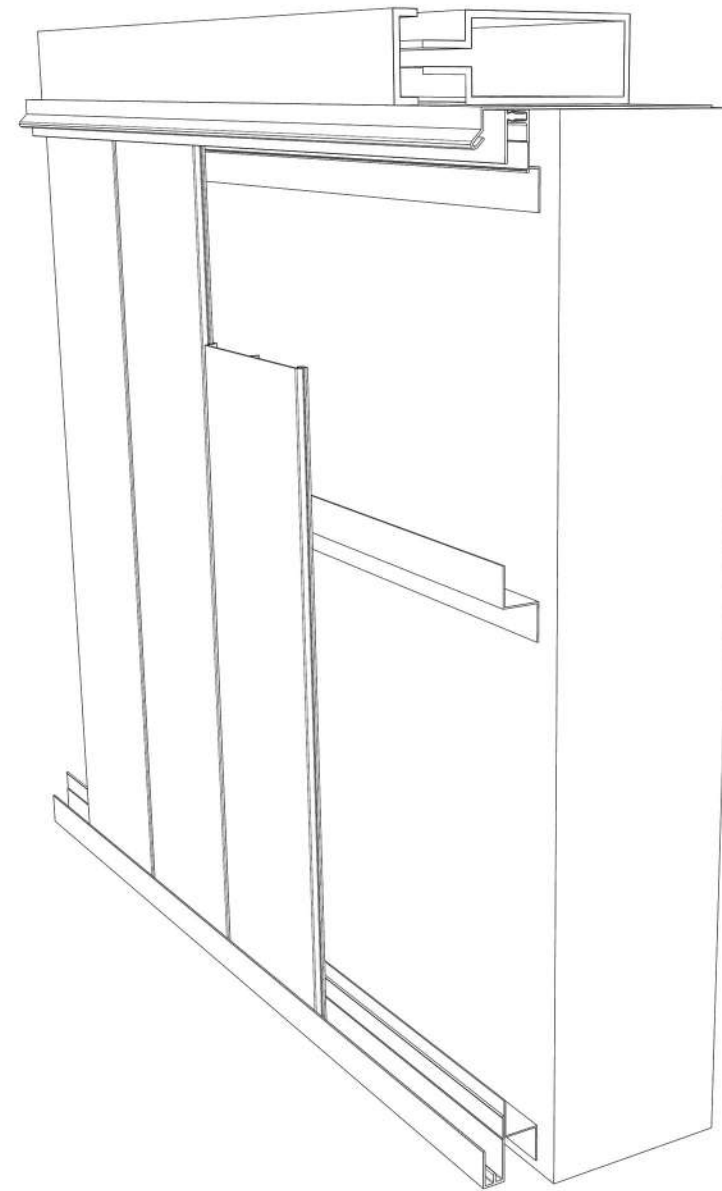

ENLARGED DETAIL A

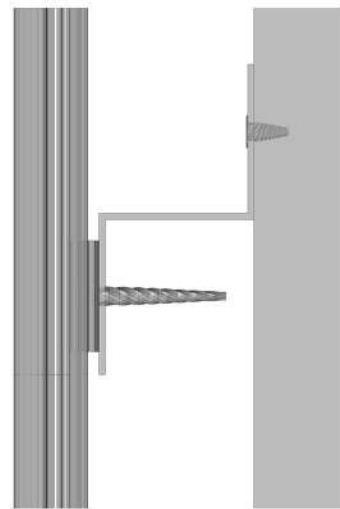

ENLARGED DETAIL B

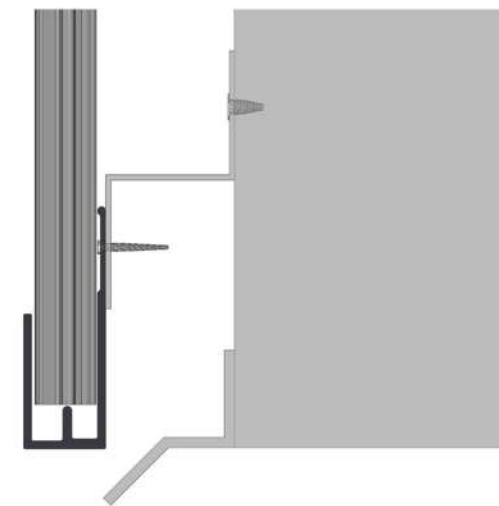

ENLARGED DETAIL C

**VEDREX**  
 ALUMINUM SYSTEMS

**A**  
**120**

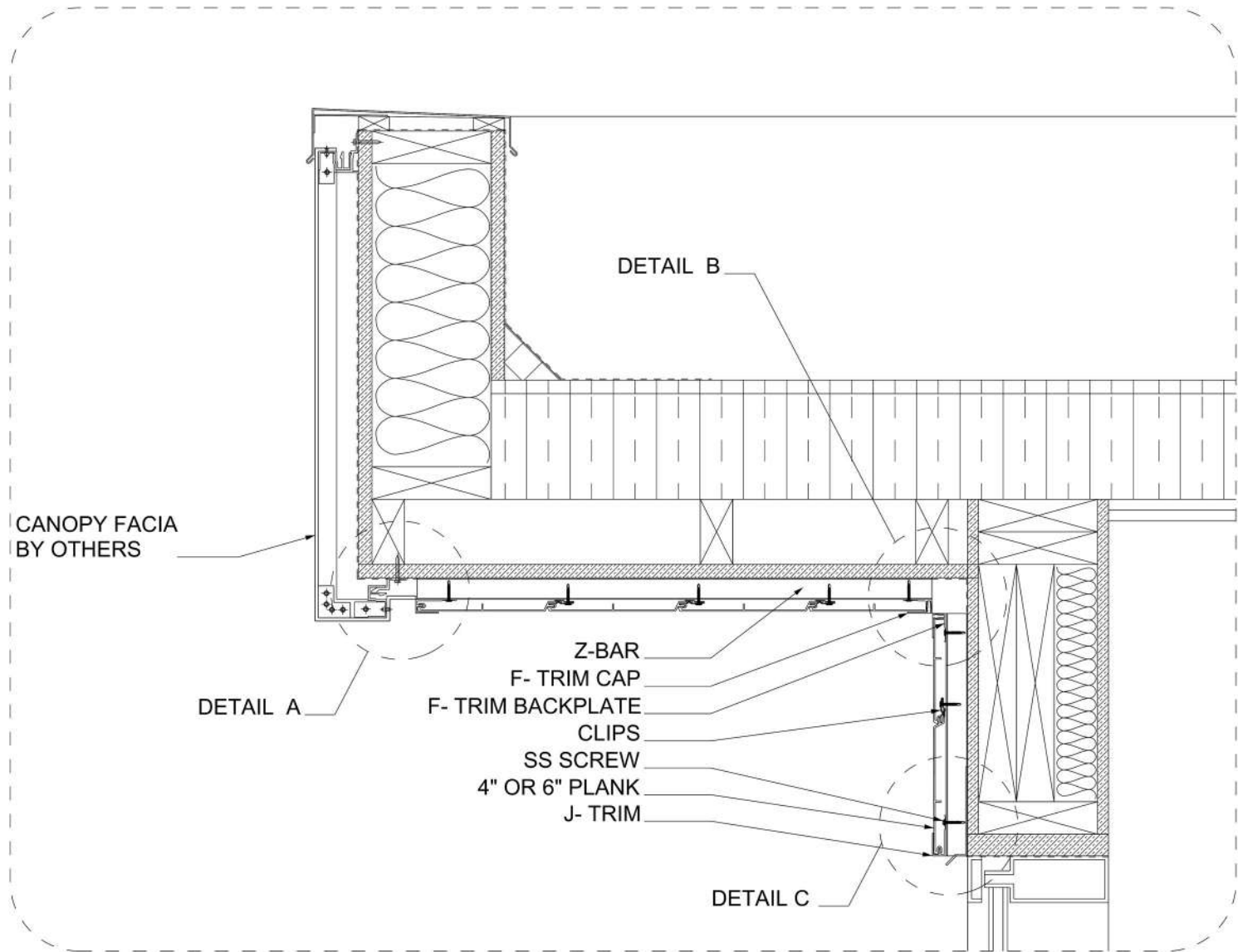

**D** DETAIL S-01  
 SCALE:

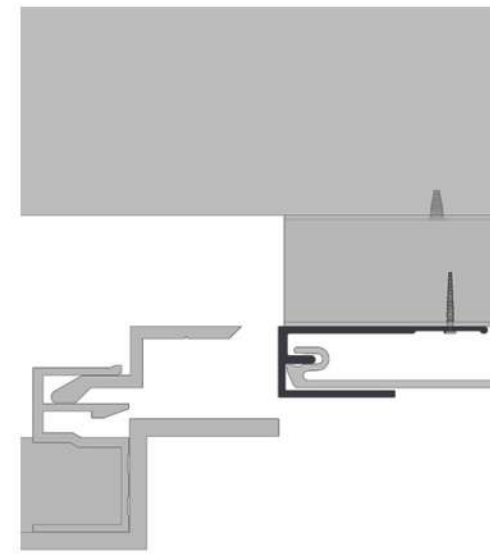
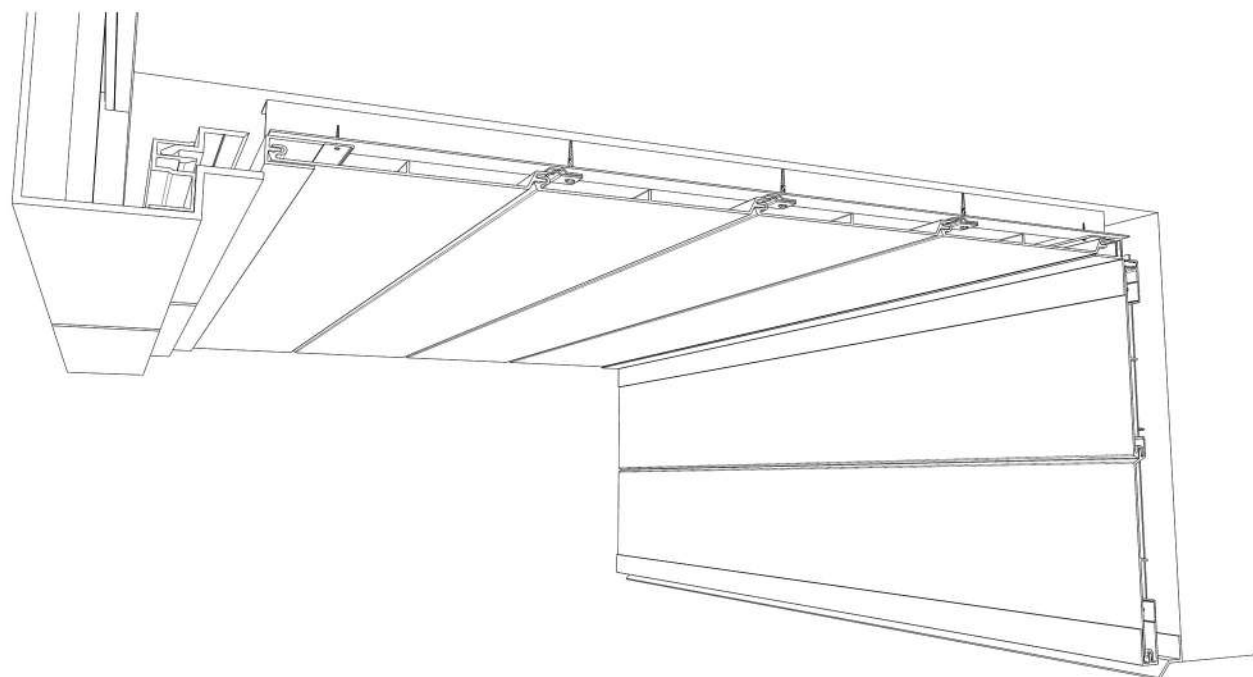

ENLARGED DETAIL A

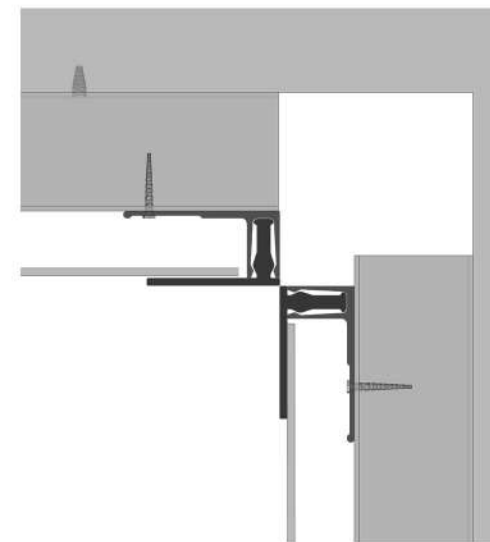

ENLARGED DETAIL B

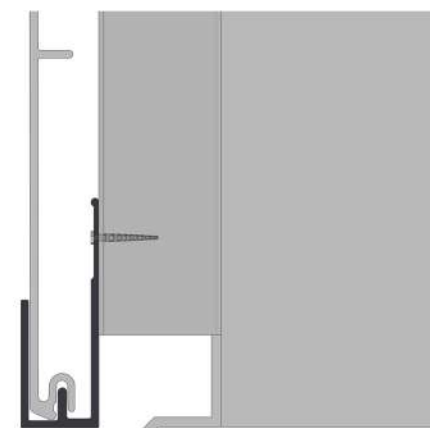

ENLARGED DETAIL C

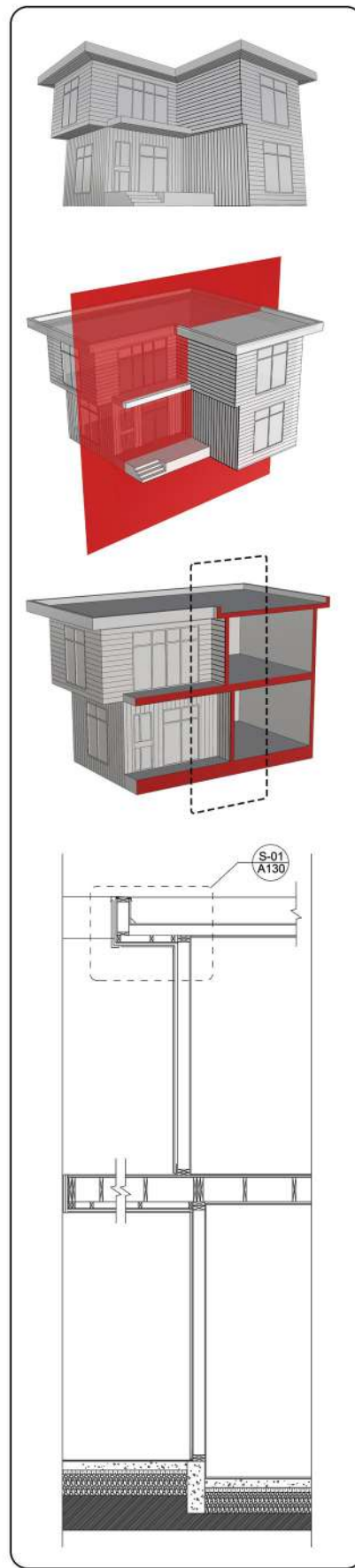

**VEDREX**  
 ALUMINUM SYSTEMS

---

**A**  
**130**

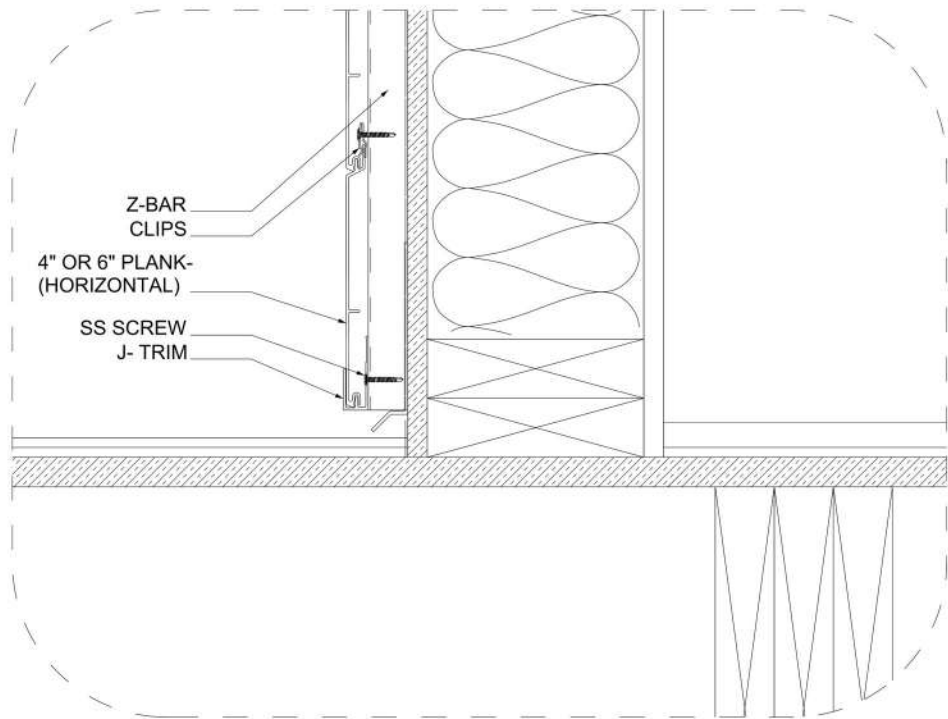

**D**ETAIL S-04

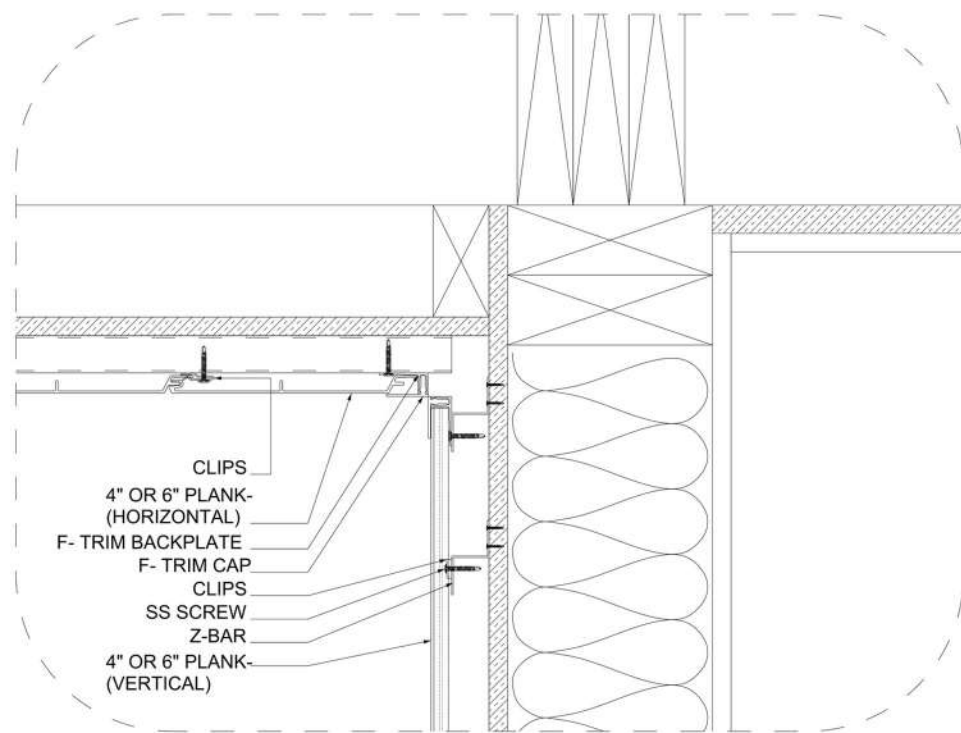
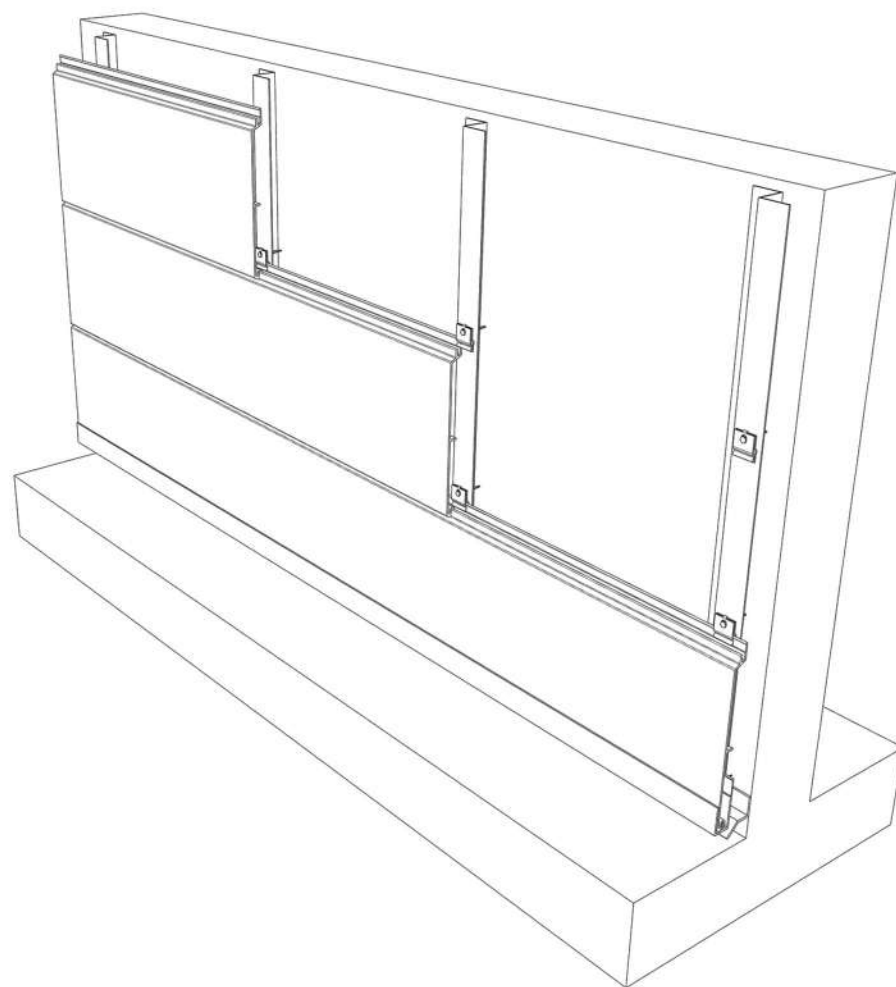
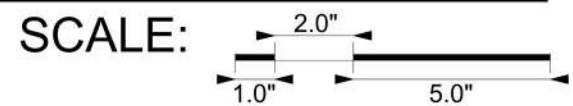

**D**ETAIL S-05

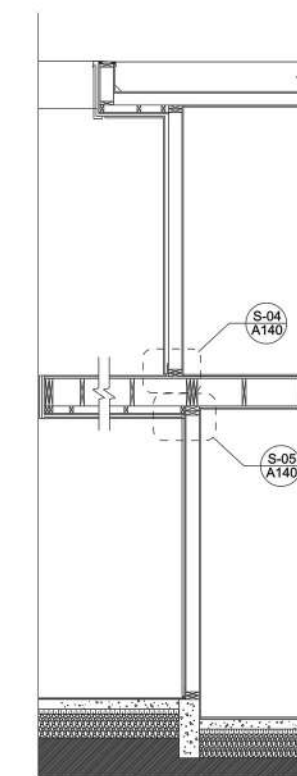
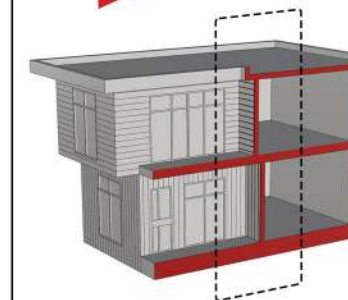
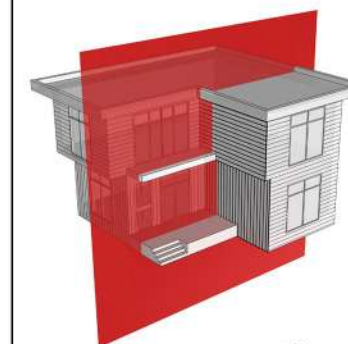
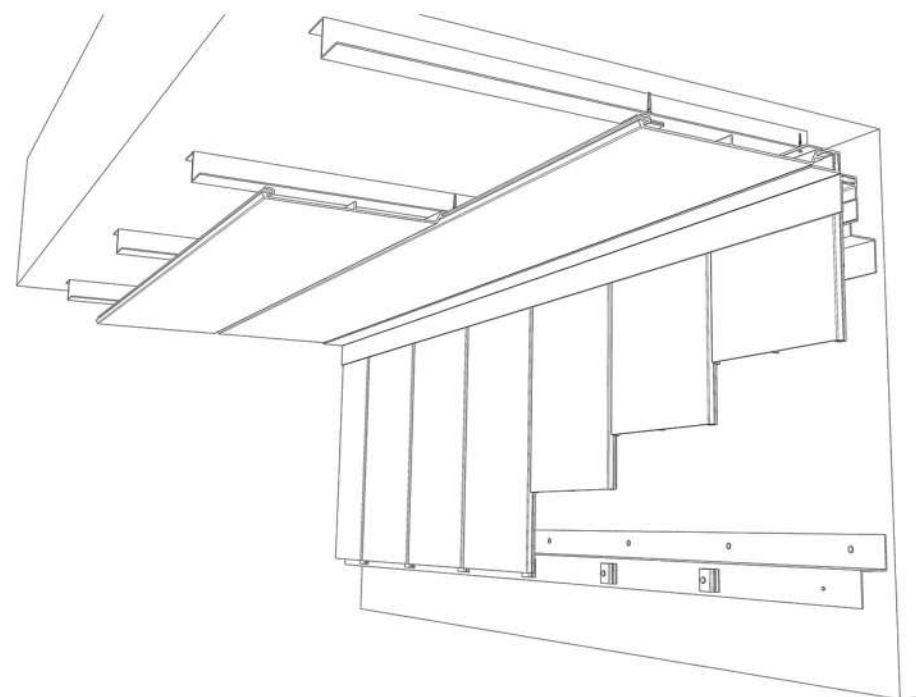
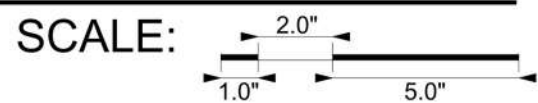

**VEDREX**  
ALUMINUM SYSTEMS

**A**  
**140**

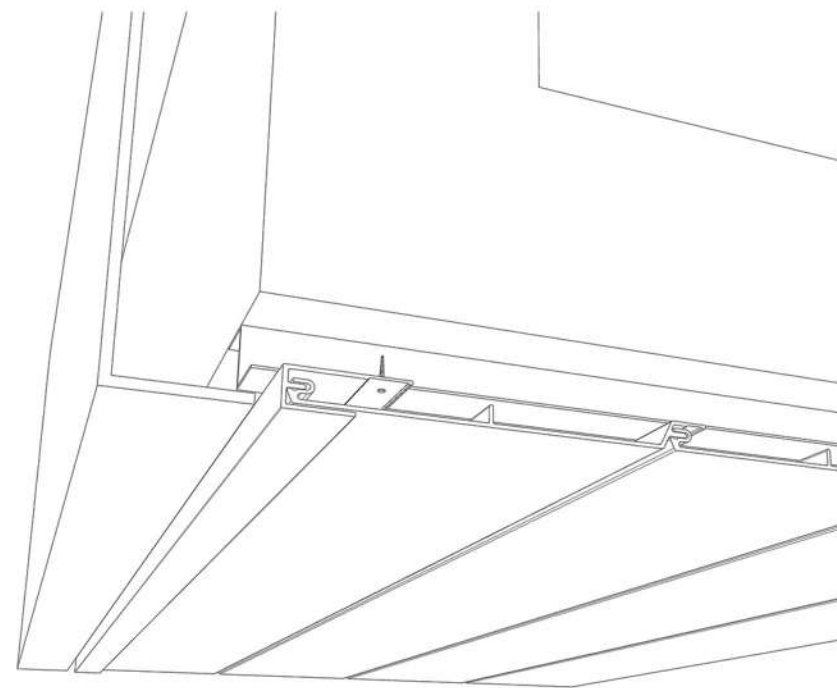
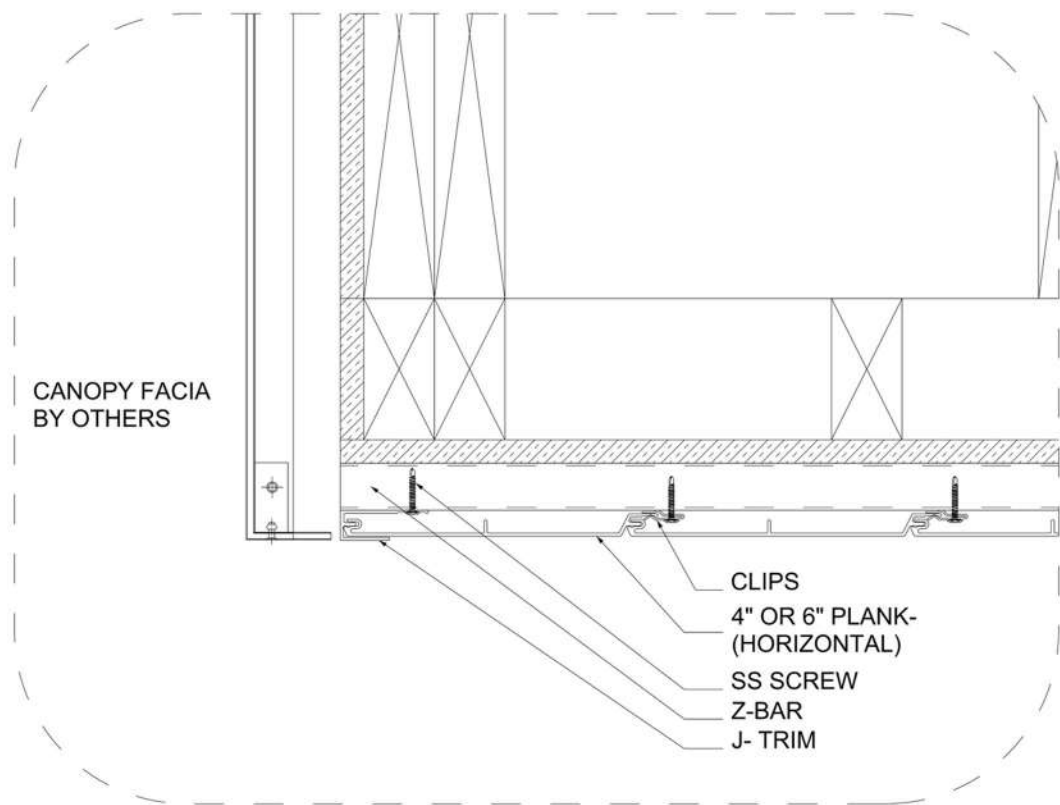

**D** **DETAIL S-06**

SCALE:

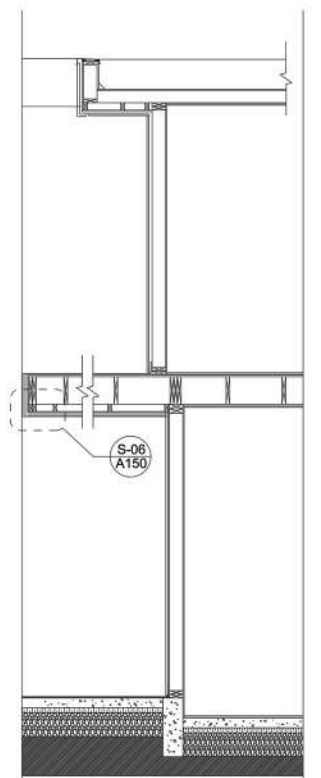
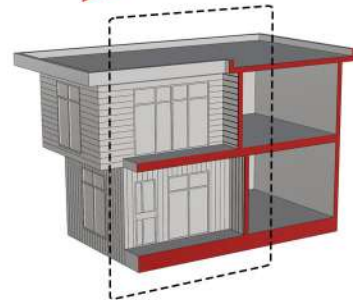
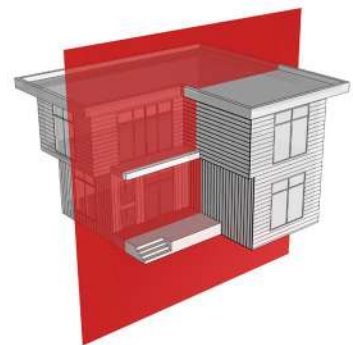
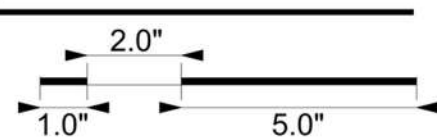

**VEDREX**  
ALUMINUM SYSTEMS

**A**  
**150**

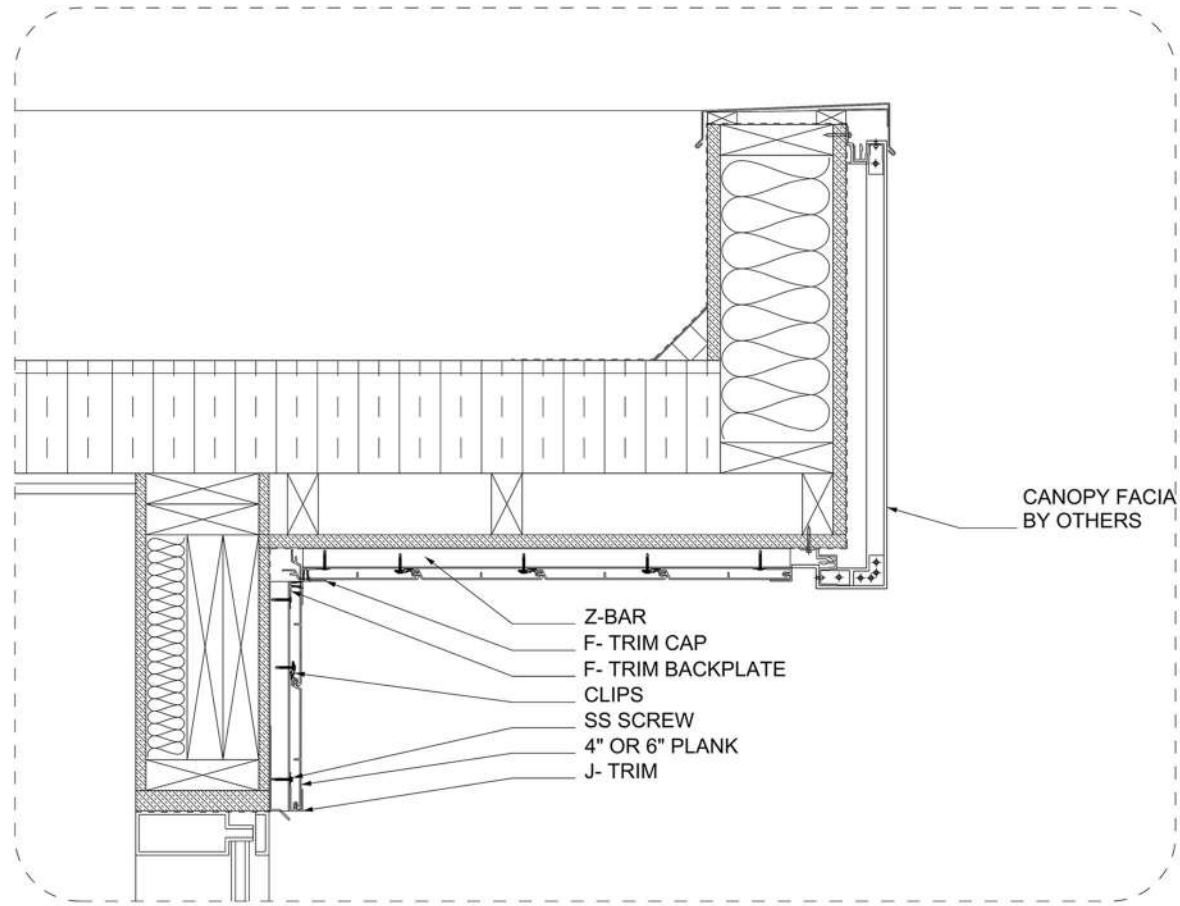

**D** DETAIL S-07  
SCALE: 1.0" 2.0" 5.0"

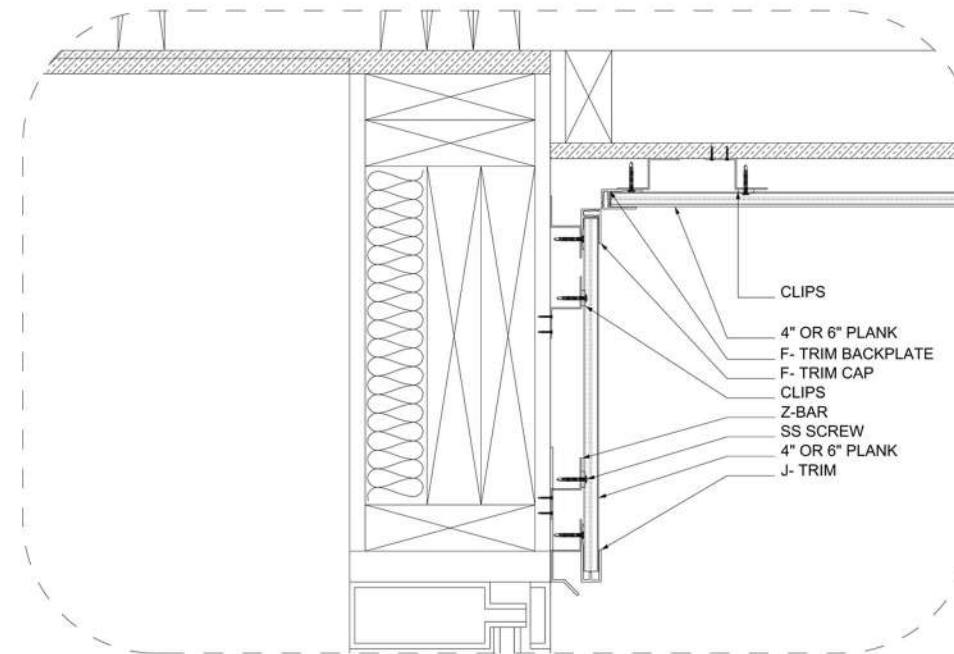

**D** DETAIL S-08  
SCALE: 1.0" 2.0" 5.0"

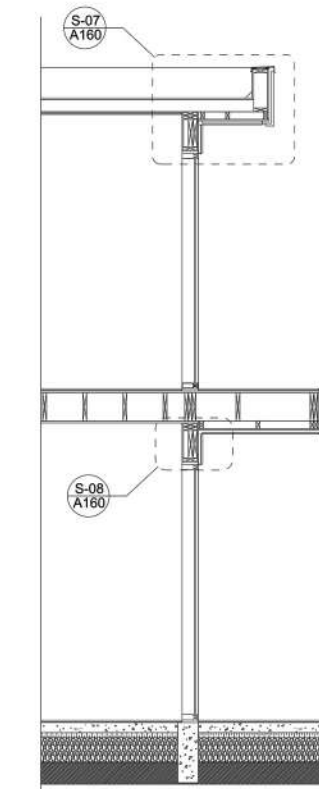
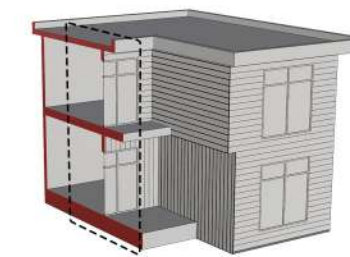
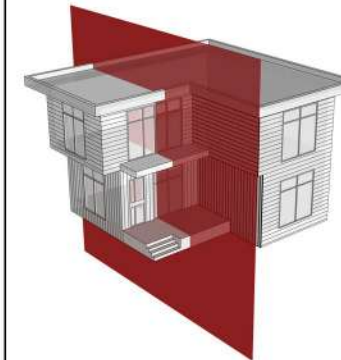
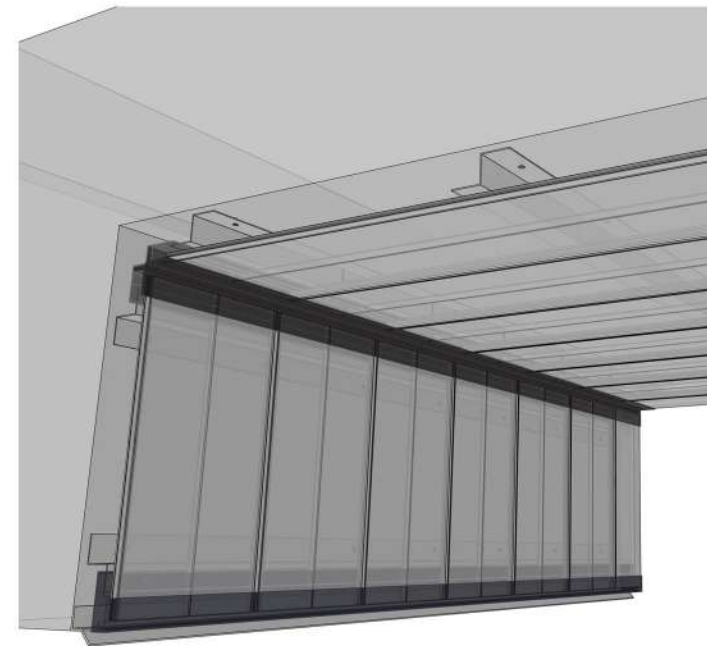
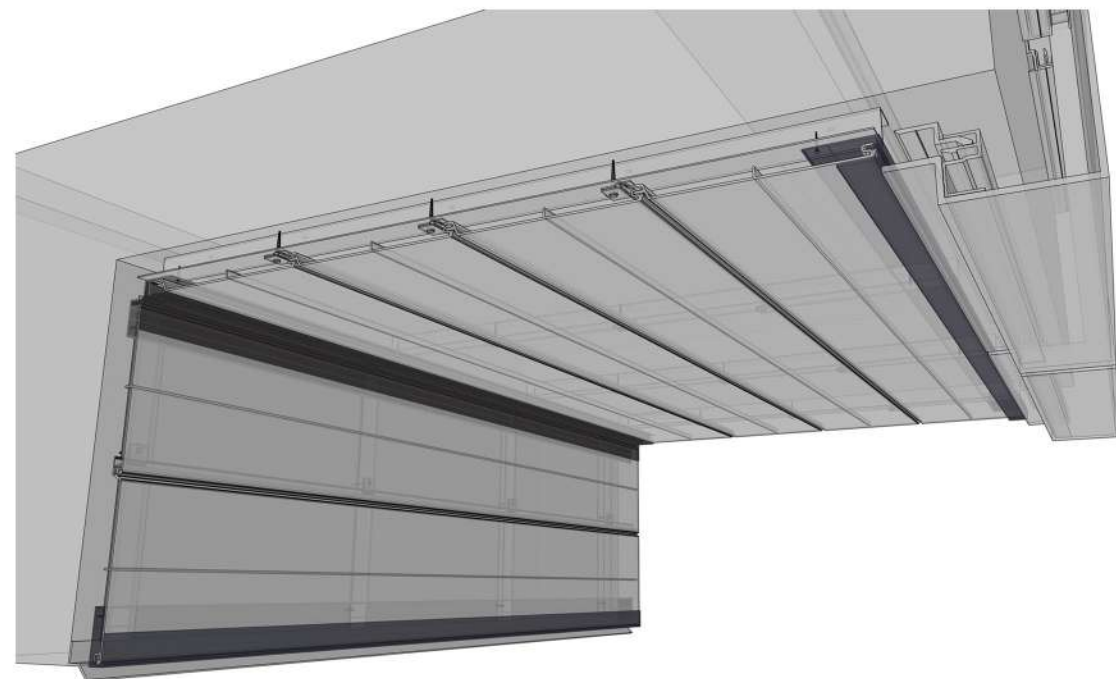

**VEDREX**  
ALUMINUM SYSTEMS

**A**  
**160**

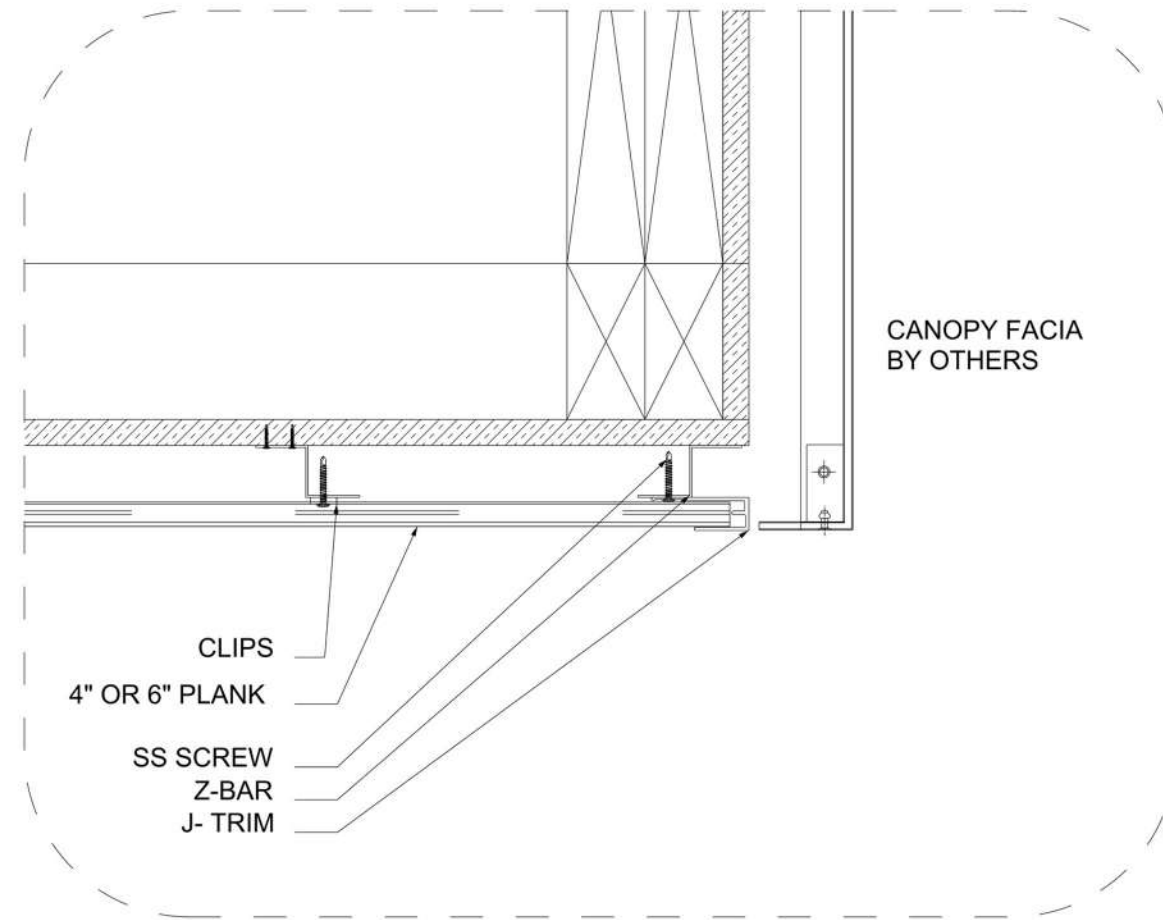

**D** **DETAIL S-09**

**SCALE:**

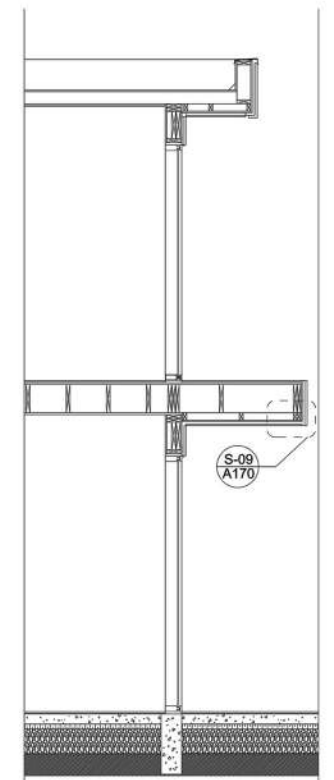
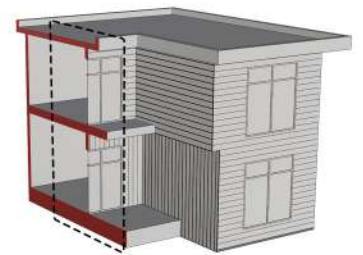
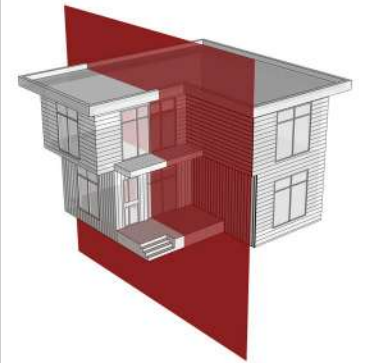
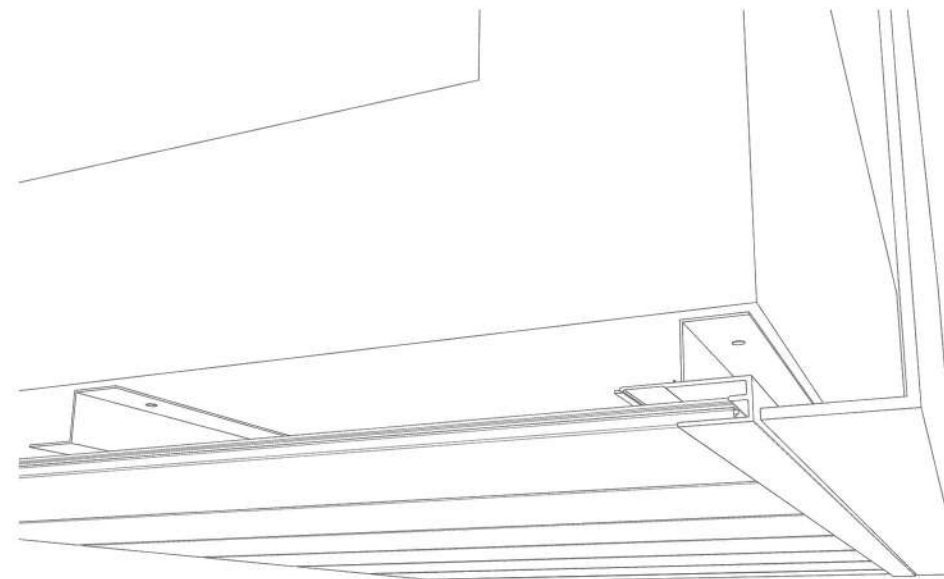
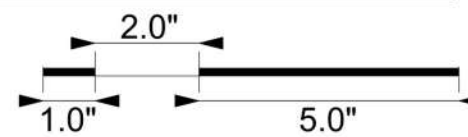

**VEDREX**  
ALUMINUM SYSTEMS

**A**  
**170**

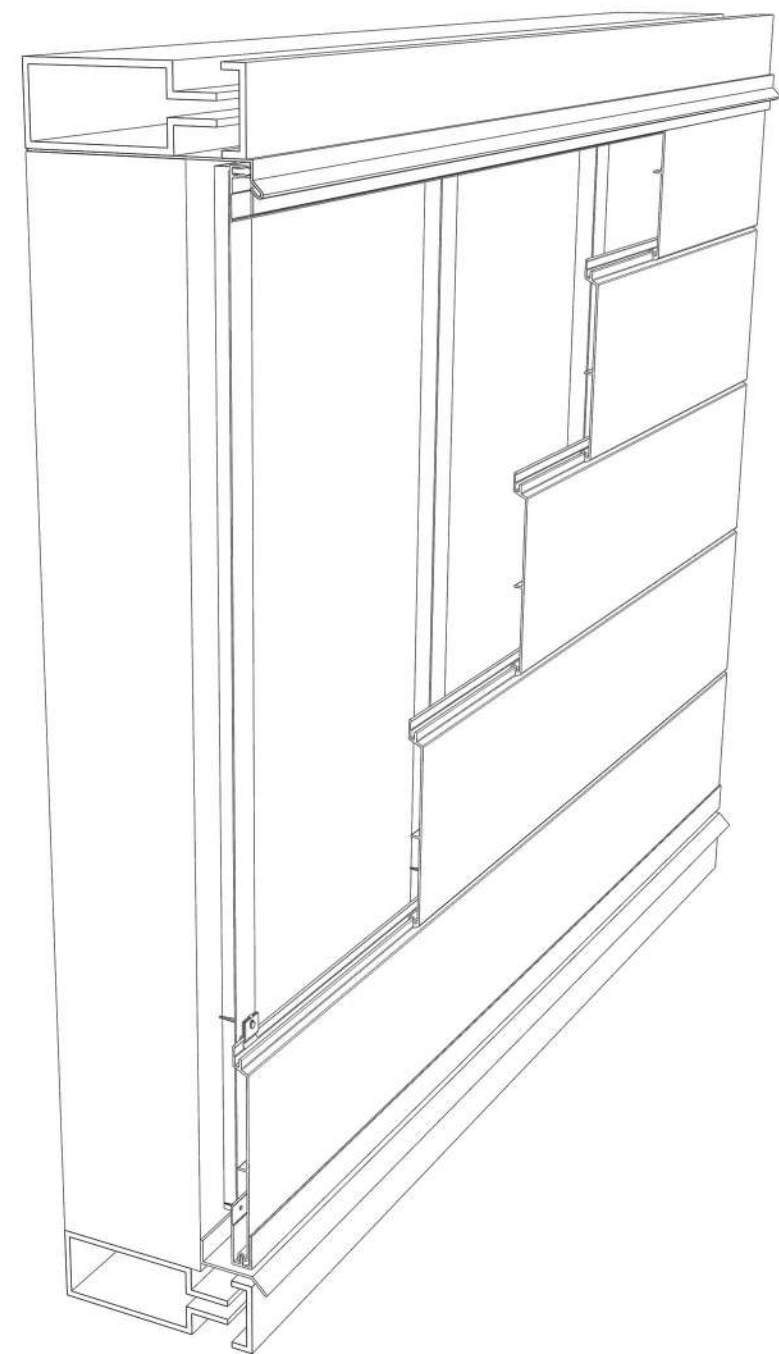
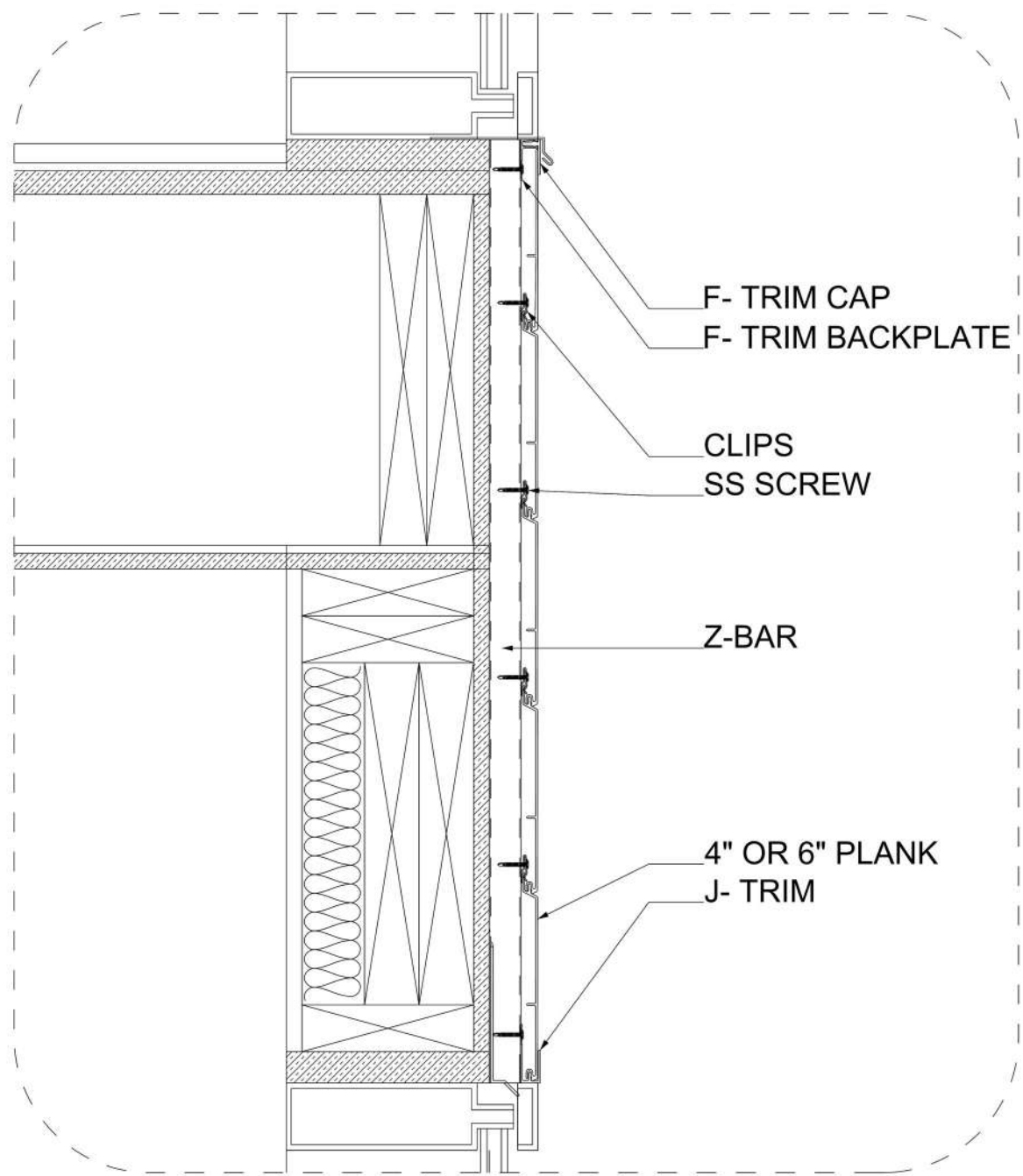

**D** DETAIL S-10  
 SCALE: 1.0" 2.0" 5.0"

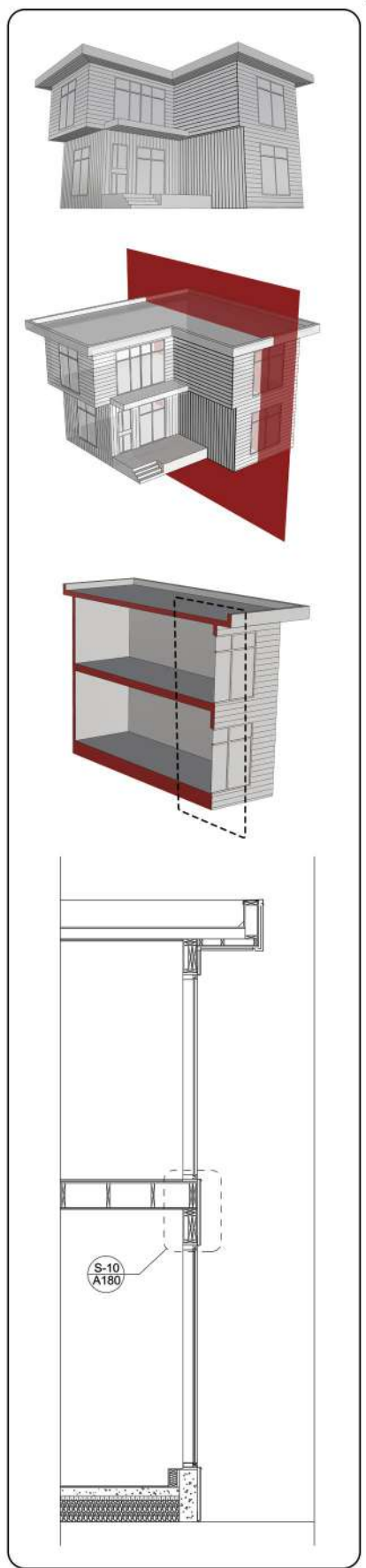

**VEDREX**  
 ALUMINUM SYSTEMS

---

**A**  
**180**